

1309*.*5:*/%6\$5*7&"9

.PEFM" ; "9

%FTDSJQUJPO

x.FUBM TIFMM %\$ UZQF NN EFUFDUJOH EJTUBODF XJSF TZT
x1PXFS TVQQMZ JOWFSUFE DPOOFDUJOH QSPYJNJUZ TXJUDI JT DMPTF UP TPNF UBSHFU PCKFDU J
x8IFO QSPYJNJUZ TXJUDI JT DMPTF UP TPNF UBSHFU PCKFDU J
x6TFEEMZ JO UIF NBDIJOF UPPM JOEVTUSZ GSFRVFODZ DPVOU

4QFDJGJDBUJPO

1SPEVDU /BNF	*OEVDUJWF 1SIPYJNJUZ 4XJUD
.PEFM	-+ " ; "9
5IFPSZ	*OEVDUJWF 4FOTPS
8JSF 5ZQF	8JSF 5ZQF #SPXO #MVF #MBDL
4XJUDI "QQFBSB\$ZMFOZQS 5ZQF .FUBM 4IFMM	
0VUQVU 5ZQF	/1/ /\$ /PSM\$MPTFE
%FUFODUUBODF	NN
&MFDU\$M\$DBMF7	7 % \$
4FWTUBODF	_ NN
0VUQVSS\$FOBY	N"
%FUFDU PCKFDU	*TSPO
4UBOEBSE %CFUFD\$UJOF OY ONN	
3FTQP\$FRVFODZ%\$ L)\$)]	
\$PMVNO 4FOTPS %NBNFUFS	
5ISFBE %JBNFUFS	NN
5PUBMF 4	YNN - %
\$BCM\$HUI	N
&YUFS\$UBMSJBM	1MBT\$UBM.
\$PMPS	4JMWFS 5POX (SBZ :FMMP



Dimension			M8	
Detection distance			2mm	
Dimensional drawing				
Model	DC Type	NPN	NO	LJ8A3-2-Z/BX
			NC	LJ8A3-2-Z/AX
			NO+NC	
		PNP	NO	LJ8A3-2-Z/BY
			NC	LJ8A3-2-Z/AY
			NO+NC	
	Two-wire	NO	LJ8A3-2-Z/EX	
		NC	LJ8A3-2-Z/DX	
	AC Type	Two-wire	NO	LJ8A3-2-J/EZ
			NC	LJ8A3-2-J/DZ
Three-wire		NO+NC		

*** O T U B M M B U J P O**

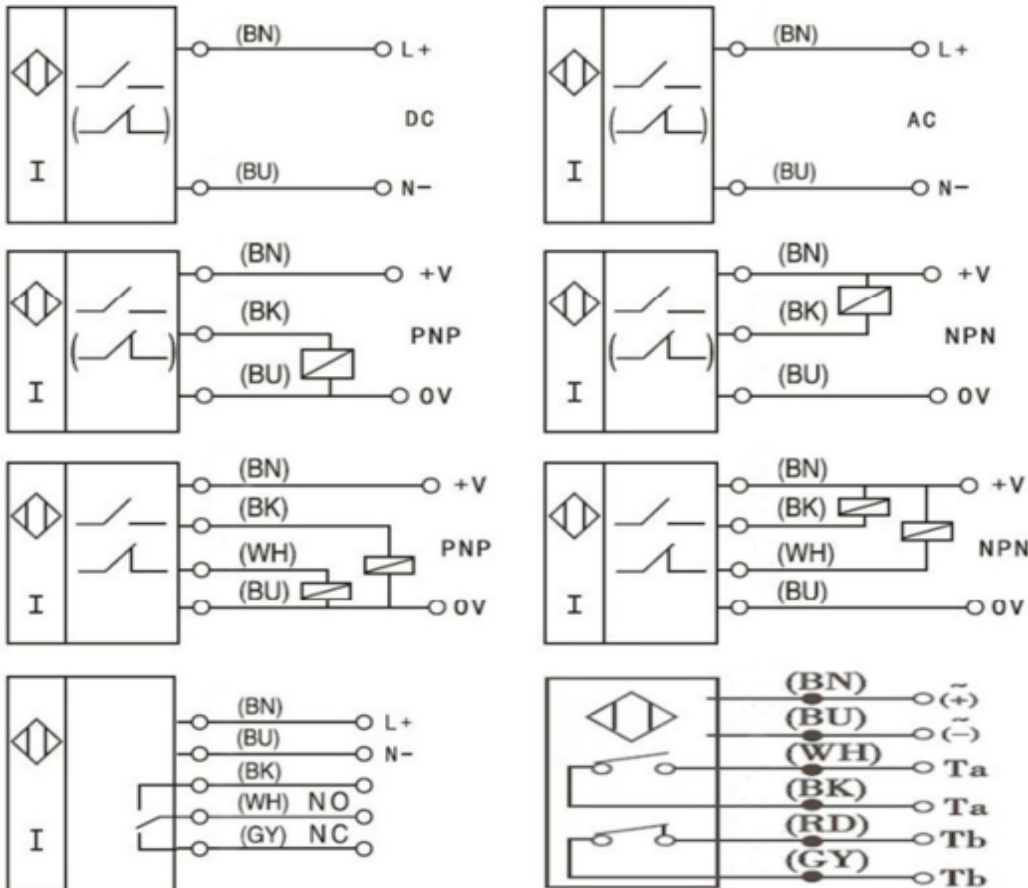

1、Various position detection in machining centre

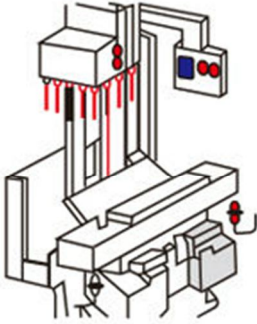

Cylindrical type proximity switch

2、Action sequence cam detection

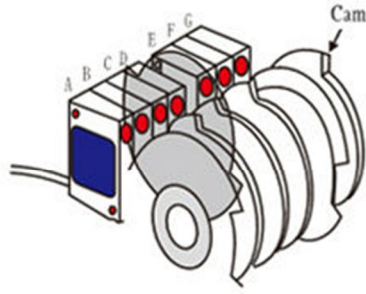

Flat type proximity switch

3、Pulser

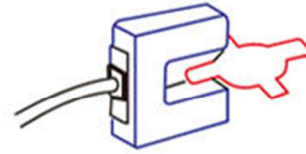

Slot type proximity switch

4、Bottle cap detection

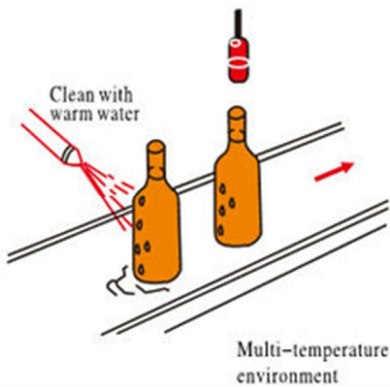

Water-proof type proximity switch

5、Grinder stop detection

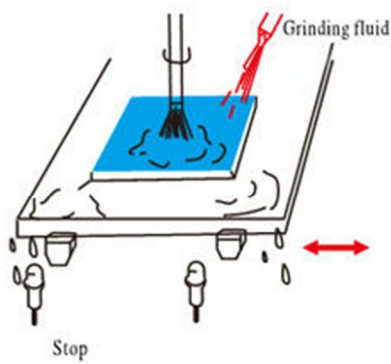

Water-proof type proximity switch

6、Detect whether there is milk inside the paper packet

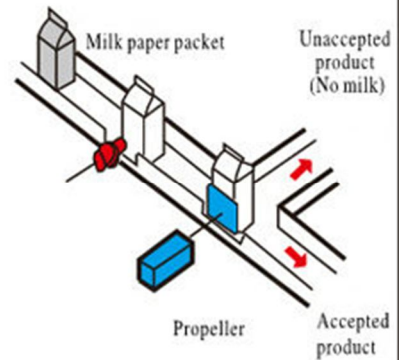

Capacitive type proximity switch