



ISO 9001  
CE



## Gas Burner Controls

## LFL1...

### Gas burner controls

- for gas, oil or dual-fuel forced draft burners of medium to high capacity
- for multistage or modulating burners in intermittent operation; for safety reasons, at least one controlled shutdown must take place every 24 hours
- with checked air damper control
- flame supervision
  - with UV detectors QRA...
  - with ionization probe

The LFL1... and this Data Sheet are intended for use by OEMs which integrate the burner controls in their products.

### Use

- Control and supervision of forced draft burners of expanding flame and interrupted pilot construction
- For medium to high capacity
- For intermittent operation (at least one controlled shutdown every 24 hours)
- Universally applicable for multistage or modulating burners
- For use with dual-fuel burners
- For use with stationary air heaters

The difference between 01 series and 02 series is the duration of the safety time for the pilot burner of burners equipped with pilot gas valves.

For atmospheric burners of high capacity, LFL1.638 is the type to be employed.

For burner controls for use with burners in continuous operation, refer to Data Sheet 7785 (LGK16...).



**To avoid injury to persons, damage to property or the environment, the following warning notes should be observed!**

**Do not open, interfere with or modify the unit!**

- Before performing any wiring changes in the connection area of the LFL1..., completely isolate the unit from the mains supply (all-polar disconnection)
- Ensure protection against electric shock hazard by providing adequate protection for the burner control's connection terminals
- Check to ensure that wiring is in an orderly state
- Press the lockout reset button only manually (apply a force of no more than 10 N), without using any tools or pointed objects
- **Do not press the lockout reset button on the unit or the remote lockout reset button for more than 10 seconds since this damages the lockout relay in the unit**
- Fall or shock can adversely affect the safety functions. Such units may not be put into operation, even if they do not exhibit any damage
- In the case of flame supervision with UV detectors QRA..., it should be noted that sources of radiation such as halogen lamps, welding equipment, special lamps, ignition sparks, as well as X-rays and gamma radiation, can produce erroneous flame signals

## Engineering notes

- Install switches, fuses, earthing, etc., in compliance with local regulations
- Decisive for the connection of valves and other plant components is the plant diagram provided by the burner manufacturer

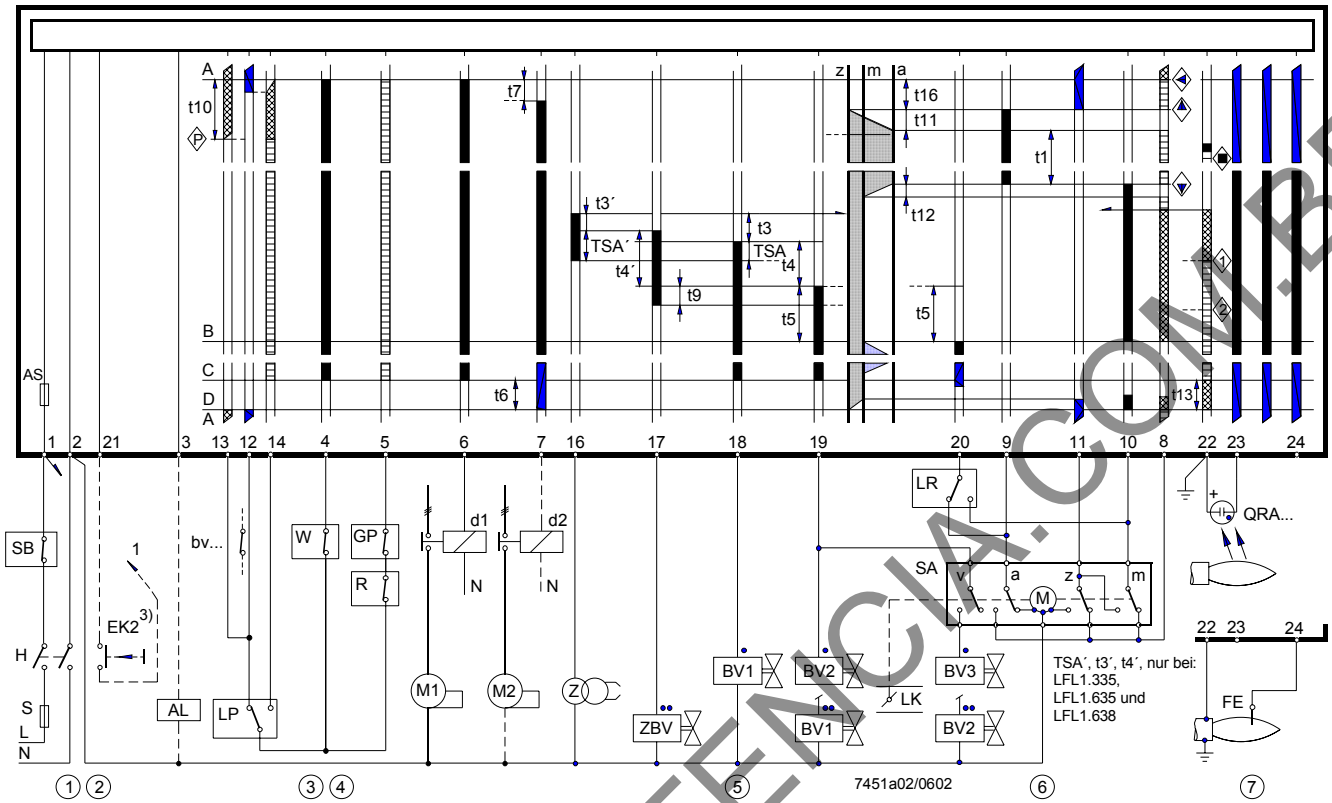

①	Connect safety limit thermostat in the line (manual reset, e.g. «SB»)
②	Remote reset When remote reset button «EK2» is connected to - terminal 3, only remote reset is possible - terminal 1, both remote emergency shutdown and remote reset are possible
③	Required switching capacities - of the switching devices connected between terminals 12 and 4 (refer to «Technical data») - of the switching devices connected between terminals 4 and 14 (refer to «Technical data») - depending on the loads applied to terminals 16...19 (refer to «Technical data»)
④	Air pressure supervision If the air pressure is not monitored by means of air pressure switch «LP», terminal 4 must be connected to terminal 12, and terminal 6 to terminal 14. Terminal 13 is not used. Control contacts of the other devices in the burner installation – if series-connected – are to be connected as follows: - To terminal 4 or 5 → contacts which must be closed from startup to controlled shutdown → otherwise no start or shutdown - To terminal 12 → contacts which must only be closed on startup → otherwise no start - To terminal 14 → contacts which must be closed at the beginning of the preignition time at the latest, and which must stay closed until controlled shutdown occurs → otherwise lockout; this applies to both long and short preignition
⑤	• Connection of fuel valves with expanding flame burners. With 2-stage burners, «BV2» is connected in place of «BV3» •• Connection of fuel valves with interrupted pilot burners Direct connection of a fuel valve to terminal 20 is only permitted - in plants with a main shutoff valve on the mains side (safety shutoff valve), which is controlled by terminal 18 or 19, and - if 2-stage valves are used, provided they fully close when the first stage, controlled by terminal 18 or 19, is switched off
⑥	For additional examples of air damper control, refer to «Connection examples». In the case of actuators with no end switch «z» for the fully closed position of the air damper, terminal 11 must be connected to terminal 10 → otherwise no burner start.
⑦	Simultaneous use of ionization and UV supervision is possible

## Mounting notes

---

- Ensure that the relevant national safety regulations are observed
- Mounting work must be carried out by qualified staff
- When using 2 UV detectors QRA..., make certain that the detectors cannot see one another

## Installation notes

---

- Installation work must be carried out by qualified staff
- Always run the high-voltage ignition cables separately while observing the greatest possible distance to the unit and to other cables
- Do not mix up live and neutral conductors

## Electrical connection of ionization probe and flame detector

---

It is important to achieve practically disturbance- and loss-free signal transmission:

- Never run the detector cable together with other cables
  - Line capacitance reduces the magnitude of the flame signal.
  - Use a separate cable of low capacitance
- Observe the maximum permissible detector cable lengths (refer to «Technical data»)
- 2 UV detectors QRA... can be connected in parallel
- The ionization probe is not protected against electric shock hazard
- Locate the ignition electrode and ionization probe such that the ignition spark cannot arc over to the ionization probe (risk of electrical overloads)
- In connection with the QRA..., earthing of terminal 22 is mandatory
- Supervision with both ionization probe and UV detector QRA... is possible, but for safety reasons – with the exception of the second safety time «t9» – only one flame detector may be active at a time. At the end of the second safety time, one of the detectors must be inactive, however, that is, the detected flame must have extinguished, e.g. by switching off the ignition valve at terminal 17

## Commissioning notes

---

- Commissioning work must be carried out by qualified staff
- Prior to commissioning, check to ensure that wiring is in an orderly state
- When commissioning the plant or when doing maintenance work, make the following safety checks:

	Safety check to be carried out	Anticipated response
a)	Burner start with flame detector darkened	Lockout at the end of «TSA»
b)	Burner start with flame detector exposed to extraneous light	Lockout after 40 seconds at the latest
c)	Burner operation with simulated loss of flame; for that purpose, darken the flame detector in operation and maintain that state (not possible with ionization)	Lockout

**Certificate**

**CE** Conformity to EEC directives  
 - Electromagnetic compatibility EMC (immunity)  
 - Low-voltage directive

89 / 336 EEC  
 73 / 23 EEC



ISO 9001: 2000  
 Cert. 00739



ISO 14001: 1996  
 Cert. 38233

Type	SA	GL	DVGW	DIN	UL	PGT
LFL1.122	X	---	X	X	X	X
LFL1.133	X	---	X	X	---	X
LFL1.322	X	---	X	X	X	X
LFL1.333	X	---	X	X	X	X
LFL1.335	X	X	X	X	X	X
LFL1.622	X	---	X	X	X	X
LFL1.635	X	---	X	X	X	X
LFL1.638	X	---	X	---	X	---

- Identification code to EN 298  
 – All types (except LFL1.148)      F B L L X N

**Service notes**

- Maintenance work must be carried out by qualified staff
- Each time a unit has been replaced, check to ensure that wiring is in an orderly state. Make the safety check in accordance with section «Commissioning notes»

**Disposal notes**



The unit contains electrical and electronic components and may not be disposed of together with household waste.  
 Local and currently valid legislation must be observed.

## Mechanical design

- Gas burner control
- Plug-in design
  - Exchangeable unit fuse (incl. spare fuse)
- Housing
- Made of impact-proof and heat-resistant black plastic
  - Lockout reset button with viewing window showing
    - the fault signal lamp
    - the lockout indicator
      - coupled to the program spindle
      - visible in the transparent lockout reset button
      - uses easy-to-remember symbols to indicate the type of fault and the time lockout occurred
- Plug-in base
- Plug-in base and connectors of the LFL1... are designed such that only LFL1... type burner controls can be plugged in
  - With 24 connection terminals
  - With auxiliary terminals «31» and «32»
  - With 3 earthing terminals, joining in a lug for earthing the burner
  - With 3 neutral conductor terminals
    - prewired to terminal 2
  - With 14 knockout holes for cable entry with cable entry glands
    - 8 at the side
    - 6 in the floor
  - With 6 lateral threaded knockout holes for cable entry glands Pg11 or M16

## Type summary

Switching times are given in seconds, in the burner startup sequence, valid for 50 Hz mains frequency. At 60 Hz, the switching times are about 17 % shorter.

	Preferred use for / in:							
	Flash steam generators	Flash steam generators	D (incl. stationary air heaters) F	A D	GB	F I	B NL <sup>2)</sup>	Large atmospheric burners
	LFL1.122 <sup>1)</sup> 02 series	LFL1.133 <sup>1)</sup> 02 series	LFL1.322 <sup>1)</sup> 02 series	LFL1.333 <sup>1)</sup> 02 series	LFL1.335 <sup>1)</sup> 01 series	LFL1.622 <sup>1)</sup> 02 series	LFL1.635 <sup>1)</sup> 01 series	LFL1.638 01 series
t1	10	9	36	31.5	37.5	66	67.5	67.5
TSA	2	3	2	3	2.5	2	2.5	2.5
TSA'	---	---	---	---	5	---	5	5
t3	4	3	4	6	5	4	5	5
t3'	---	---	---	---	2.5	---	2.5	2.5
t4	6	6	10	12	12.5	10	12.5	12.5
t4'	---	---	---	---	15	---	15	15
t5	4	3	10	12	12.5	10	12.5	12.5
t6	10	14.5	12	18	15	12	15	15
t7	2	3	2	3	2.5	2	2.5	2.5
t8	30	29	60	72	78	96	105	105
t9	2	3	2	3	5	2	5	7.5
t10	6	6	8	12	10	8	10	10
t11	Optional							
t12	Optional							
t13	10	14,5	12	18	15	12	15	15
t16	4	3	4	6	5	4	5	5
t20	32	60	---	27	22.5	---	---	---

<sup>1)</sup> Available as AC 100...110 V versions; add type suffix – 110 V when ordering

<sup>2)</sup> Reversed polarity protection conforming to Dutch installation standard: AGM30

## Ordering

When ordering, please give type reference according to «Type summary».

## Accessories



### Plug-in bases

- With Pg11 threads for cable entry glands
- With M16 threads for cable entry glands

**AGM410490550**  
**AGM14.1**

## Technical data

General unit data LFL1...	Mains voltage	AC 230 V –15 / +10 % AC 100 V –15 %...AC 110 V +10 %
	Mains frequency	50...60 Hz ±6 %
	Unit fuse (built-in)	T6,3H250V to DIN EN 60 127
	Primary fuse (external)	max. 10 A (slow)
	Weight	
	- LFL1...	approx. 1,000 g
	- Plug-in base	approx. 165 g
	Flame detectors	
	- QRA...	refer to Data Sheet 7712
	- Ionization probe	to be supplied by thirds
	Power consumption	approx. AC 3.5 VA
	Mounting position	optional
	Degree of protection	IP 40, with the exception of the connection area
	Perm. input current at terminal 1	max. 5 A continuously, peaks up to 20 A for 20 ms
	Perm. load on control terminals 3, 6, 7, 9...11, 15...20	max. 4 A continuously, peaks up to 20 A for max. 20 ms, total max. 5 A
Plug-in base AGM...	Required switching capacity of switching devices	1 A, AC 250 V
	- Between terminals 4 and 5	1 A, AC 250 V
	- Between terminals 4 and 12	min. 1 A, AC 250 V
	- Between terminals 4 and 14	depending on the load on terminals 16...19
	Degree of protection	IP 00
Environmental conditions	Cable connection (stranded wires require ferrules)	screw terminals for min. 0.5 mm <sup>2</sup> and max. 1.5 mm <sup>2</sup> cross-sectional area
	Ferrules	suited for the respective cross-sectional area
	<b>Transport</b>	DIN EN 60721-3-2
Environmental conditions	Climatic conditions	class 2K2
	Mechanical conditions	class 2M2
	Temperature range	-50...+70 °C
	Humidity	< 95 % r.h.
	<b>Operation</b>	DIN EN 60 721-3-3
	Climatic conditions	class 3K5
	Mechanical conditions	class 3M2
	Temperature range	-20...+60 °C
	Humidity	< 95 % r.h.



**Condensation, formation of ice and ingress of water are not permitted!**

Flame supervision with ionization probe

Voltage at the ionization probe	
- Operation	AC 330 V ±10 %
- Test	AC 380 V ±10 %
Short-circuit current	max. 0.5 mA
Required ionization current	min. 6 µA
Recommended range of measuring instrument	0...50 µA
Perm. length of detector cable	
- Normal cable, laid separately <sup>2)</sup>	max. 80 m
- Shielded cable	max. 140 m (e.g. high-frequency cable; shield connected to terminal 22)

Flame supervision with QRA...

Supply voltage	
- Operation	AC 330 V ±10 %
- Test	AC 380 V ±10 %
Required detector current	min. 70 µA
Possible detector current	
- Operation	max. 680 µA
- Test	max. 1000 µA <sup>1)</sup>
Perm. length of detector cable	
- Normal cable, laid separately <sup>2)</sup>	max. 100 m
- Shielded cable	max. 200 m (e.g. high-frequency cable; shield connected to terminal 22)

<sup>1)</sup> During the prepurge time with higher test voltage: Self-ignition and extraneous light test

<sup>2)</sup> Multicore cable not permitted

Measuring circuit for detector current measurement

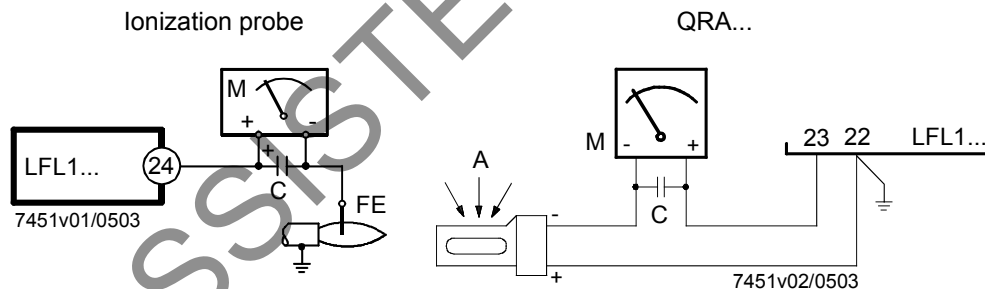

For detector currents, refer to «Technical data».

Legend

- C Electrolytic condenser 100...470 µF; DC 10...25 V
- FE Ionization probe
- M Microammeter Ri max. 5,000 Ω



## Function

### 2-stage expanding flame burner

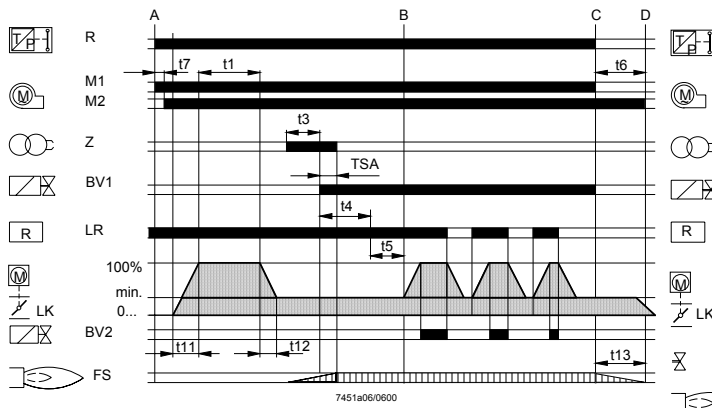

### Modulating expanding flame burner

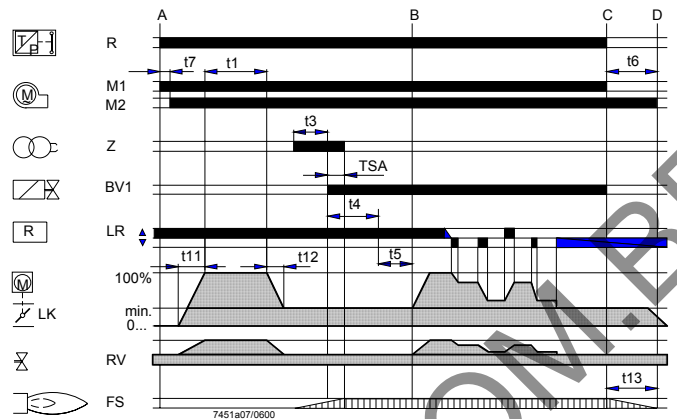

### 2-stage interrupted pilot burner

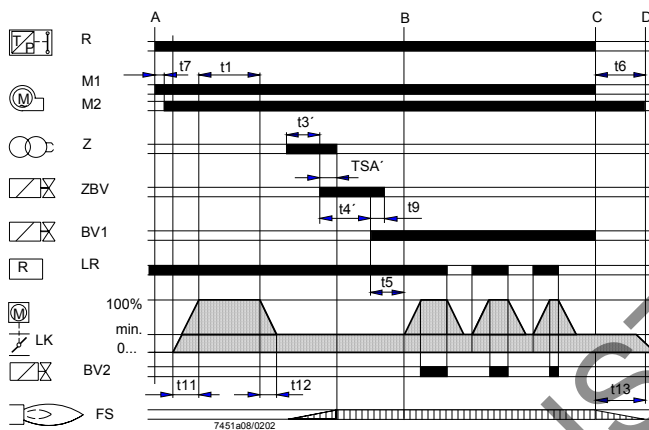

#### Legend

BV...	Fuel valve
FS	Flame signal amplifier
LK	Air damper
LR	Load controller
M...	Fan or burner motor
R	Control thermostat or pressurestat
RV	Modulating fuel valve
Z	Ignition transformer

## General

The following features enable the LFL1... to offer a high level of additional safety:

- Detector and extraneous light test are resumed immediately on completion of the afterburn time «t13». Fuel valves that are not closed, or not fully closed, immediately initiate lockout on completion of the afterburn time «t13». The test will only be terminated when the prepurge time «t1» of the next startup sequence has elapsed
- The proper functioning of the flame supervision circuit is automatically checked during each startup phase of the burner
- During the postpurge time «t6», the control contacts for the release of fuel are checked to ensure they have not welded
- The built-in unit fuse protects the control contacts against overloads

- Control of the burner
- Burner operation with or without postpurging
  - Fan motors with a current draw of up to 4 A can be connected directly → starting current max. 20 A (max. 20 ms)
  - Separate control outputs for
    - one pilot valve, which will be shut on completion of the second safety time
  - Separate control outputs for the actuator's positioning directions OPEN, CLOSE and MIN
  - Checked air damper control to ensure prepurging with the nominal amount of air
  - Checked positions:
    - CLOSED or MIN on startup → low-fire position
    - OPEN at the start of prepurging
    - MIN on completion of prepurging
 If the actuator does not drive the air damper to the required position, the burner startup sequence will be stopped
  - 2 control outputs for the release of the second and third output stage, or load control
  - When load control is enabled, the control outputs for the actuator will galvanically be separated from the unit's control section
  - Connection facilities for
    - remote lockout warning device
    - remote reset
    - remote emergency shutdown
  - With burner controls of the 01 series and expanding flame burners, the safety time can be increased from 2.5 to 5 seconds by changing the circuitry (refer to «Connection examples»), provided the longer safety time conforms to local safety regulations
- Flame supervision
- With the ionization probe, in networks with earthed or nonearthed neutral conductor. For this kind of supervision, the flame supervision circuit is designed such that possible disturbances of the ionization current due to the ignition spark normally have no impact on the establishment of the flame signal. A short-circuit between ionization probe and burner ground cannot simulate a flame signal
  - With UV detector QRA... (gas and oil burners)
  - Simultaneous use of ionization probe and QRA... (e.g. with interrupted pilot burners or gas-electrically ignited oil burners)
- Preconditions for startup
- If, on startup, the required input signals are not present, the burner control interrupts the startup sequence at the points marked by symbols and initiates lockout where required by safety regulations. The symbols used in this Data Sheet correspond to those on the burner control's lockout indicator.
- Preconditions for burner startup
- Burner control must be reset
  - Sequence switch must be in its start position  
→ voltage at terminals 4 and 11 present  
Air damper closed
  - End switch «z» for the CLOSED position must feed voltage from terminal 11 to terminal 8
  - The contacts of control thermostat or pressurestat «W» and other contacts of switching devices connected between terminal 12 and «LP» must be closed → e.g. control contact for the oil preheater's temperature
  - Terminal 4 must be live
  - The N.C. contact of the air pressure switch must be closed → «LP» test

## Startup sequence

Sequence	A	Start command (delivered by «R» for instance)
	A-B	Startup sequence
	B	Operating position of the burner
	B-C	Burner operation (according to the control commands delivered by «R»)
	C	Controlled shutdown via «R»
	C-D	Sequence switch travels to start position «A», postpurging During burner off periods, only control outputs 11 and 12 carry voltage and the air damper is in its CLOSED position as defined by end switch «Z» of the actuator. Also, in order to perform the detector and extraneous light test, the flame supervision circuit is live (terminals 22 / 23 and 22 / 24)
	A	Start command delivered by «R» → «R» closes the start control loop between terminals 4 and 5 - The sequence switch starts running - Only prepurging, power is immediately fed to the fan motor connected to terminal 6 - Pre- and postpurging; on completion of «t7», power is fed to the fan motor or flue gas fan connected to terminal 7 - On completion of «t16», the control command to open the air damper is delivered via terminal 9 - No power is fed to terminal 8 during the positioning time - The sequence switch continues its travel only after the air damper has fully opened
	t1	Prepurge time with air damper fully open - During «t1», the correct functioning of the flame supervision circuit is tested - If test is not successful, the burner control will initiate lockout  Shortly after the start of «t1», the air pressure switch must change over from terminal 13 to terminal 14. → Otherwise lockout → Start of air pressure check  At the same time, terminal 14 must be live since the ignition transformer will be powered and the fuel released via this current path.  On completion of the prepurge time, the burner control will drive the air damper to the low-fire position via terminal 10, which is determined by the changeover point of auxiliary switch «m». During the positioning time, the sequence switch stops again. A short time later, the motor of the sequence switch will be switched to the control section of the burner control. This means that, from now on, positioning signals delivered to terminal 8 have no impact on the burner's further startup sequence (and on subsequent burner operation):
	t5	Interval - On completion of «t5», power is fed to terminal 20; at the same time, control outputs 9...11 and input 8 are galvanically separated from the unit's control section → The LFL1... is now protected against return voltages from the power control loop - The startup sequence of the LFL1... ends with the release of «LR» at terminal 20 - After a number of idle steps (steps with no change of the contact position), the sequence switch switches itself off

Expanding flame burners	TSA	Ignition safety time On completion of «TSA», a flame signal must be present at terminal 22. It must not be interrupted until controlled shutdown takes place → otherwise lockout
	t3	Preignition time Release of fuel via terminal 18
	t4	Interval «BV1 – BV2» or «BV1 - LR» - On completion of «t4», terminal 19 is live - That powers «BV2» connected to the actuator's auxiliary switch «v»
Interrupted pilot burners	t3	Preignition time
	t3'	Release of fuel for pilot burner via terminal 17
	TSA	Ignition safety time
	TSA'	On completion of «TSA», a flame signal must be present at terminal 22. It must not be interrupted until controlled shutdown takes place → otherwise lockout
	t4	Interval «ZBV-BV1»
	t4'	Up to the release of the fuel valve at terminal 19 for the main burner's start load
	t9	Second safety time On completion of the second safety time, the main burner must have been ignited by the pilot burner since terminal 17 becomes dead as soon as this time has elapsed, causing the pilot valve to close
	B	Operating position of the burner
	B-C	Burner operation - During burner operation, «LR» drives the air damper to the high-fire or low-fire position, depending on the demand for heat - Release of high-fire is enabled by auxiliary switch «v» in the actuator - In the event of loss of flame during operation, the LFL1... will initiate lockout
	C	Controlled shutdown On controlled shutdown, the «BV...» will immediately be closed. At the same time, the sequence switch starts and programs «t6»
C-D	The sequence switch travels to start position «A»	
t6	Postpurge time - Fan «M2» connected to terminal 7 - Shortly after the start of «t6», power is fed to terminal 10 → air damper will be driven to the MIN position - Full closing of the air damper starts only shortly before «t6» has elapsed → triggered by the control signal at terminal 11 - During the following burner off period, terminal 11 remains live	
t13	Permissible afterburn time During «t13», the flame signal input can still receive a flame signal → no lockout	

D-A End of control sequence

→ start position

As soon as the sequence switch has reached the start position – thereby switching itself off – the flame detector and extraneous light test will start again.

During the burner off periods, the flame supervision circuit is live.

A faulty flame signal of a few seconds will initiate lockout.

Short ignition pulses of the UV tube, caused for instance by cosmic radiation, do not lead to lockout.

Times «TSA'», «t3'» and «t4'» only exist with burner controls of the 01 series.

WWW.MEAASSISTENCIA.COM.BR

## Control sequence under fault conditions and lockout indication

In the event of any kind of fault, the sequence switch will stop and, with it, the lockout indicator.

The symbol above the indicator's reading mark gives the type of fault:

◀	No start	<ul style="list-style-type: none"> <li>• One of the contacts is not closed (also refer to «Preconditions for burner startup»)</li> <li>• Extraneous light</li> </ul> <p>Lockout during or after completion of the control sequence. Examples:</p> <ul style="list-style-type: none"> <li>– Flames that have not extinguished</li> <li>– Leaking fuel valves</li> <li>– Defect in the flame supervision circuit</li> </ul>
▲	Interruption of startup sequence	<ul style="list-style-type: none"> <li>• Terminal 8 has not received the OPEN signal from end switch «a»</li> <li>• Terminals 6, 7 and 14 remain live until the fault has been corrected</li> </ul>
P	Lockout	<ul style="list-style-type: none"> <li>• No indication of air pressure at the beginning of the air pressure check</li> <li>• Loss of air pressure after the air pressure check</li> </ul>
■	Lockout	<ul style="list-style-type: none"> <li>• Defect in the flame supervision circuit</li> </ul>
▼	Interruption of startup sequence	<ul style="list-style-type: none"> <li>• Terminal 8 has not received the positioning signal from auxiliary switch «m» for the low-fire position</li> <li>• Terminals 6, 7 and 14 remain live until the fault has been corrected</li> </ul>
1	Lockout	<ul style="list-style-type: none"> <li>• No flame signal on completion of safety time «TSA»</li> </ul>
2	Lockout	<ul style="list-style-type: none"> <li>• No flame signal on completion of the second safety time (flame signal of main flame with interrupted pilot burners)</li> </ul>
I	Lockout	<ul style="list-style-type: none"> <li>• Loss of flame signal during operation</li> </ul>

If lockout occurs any other moment in time between start and preignition not indicated by a symbol, the usual cause is a premature flame signal, that is, a faulty flame signal, caused for instance by a self-igniting UV tube.

Lockout indicator

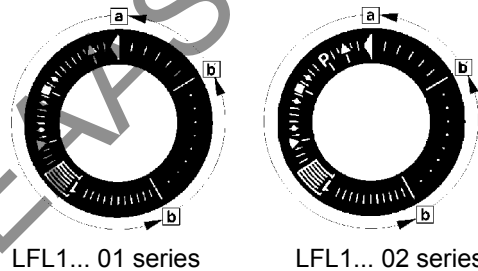

a-b Startup sequence

b-b' Idle steps  
(with no contact confirmation)

b (b')-a Postpurge program

- If lockout occurs, the burner control can immediately be reset:
  - Do not press the lockout reset button for more than 10 seconds
- The sequence switch always returns to its start position first
  - After resetting
  - After correction of a fault which resulted in plant shutdown
  - After each power failure

During that period of time, power is only fed to terminals 7 and 9...11.
- Then, the LFL1... begins with a new burner startup sequence

Connection diagrams (for circuit variants, refer to «Connection examples»)

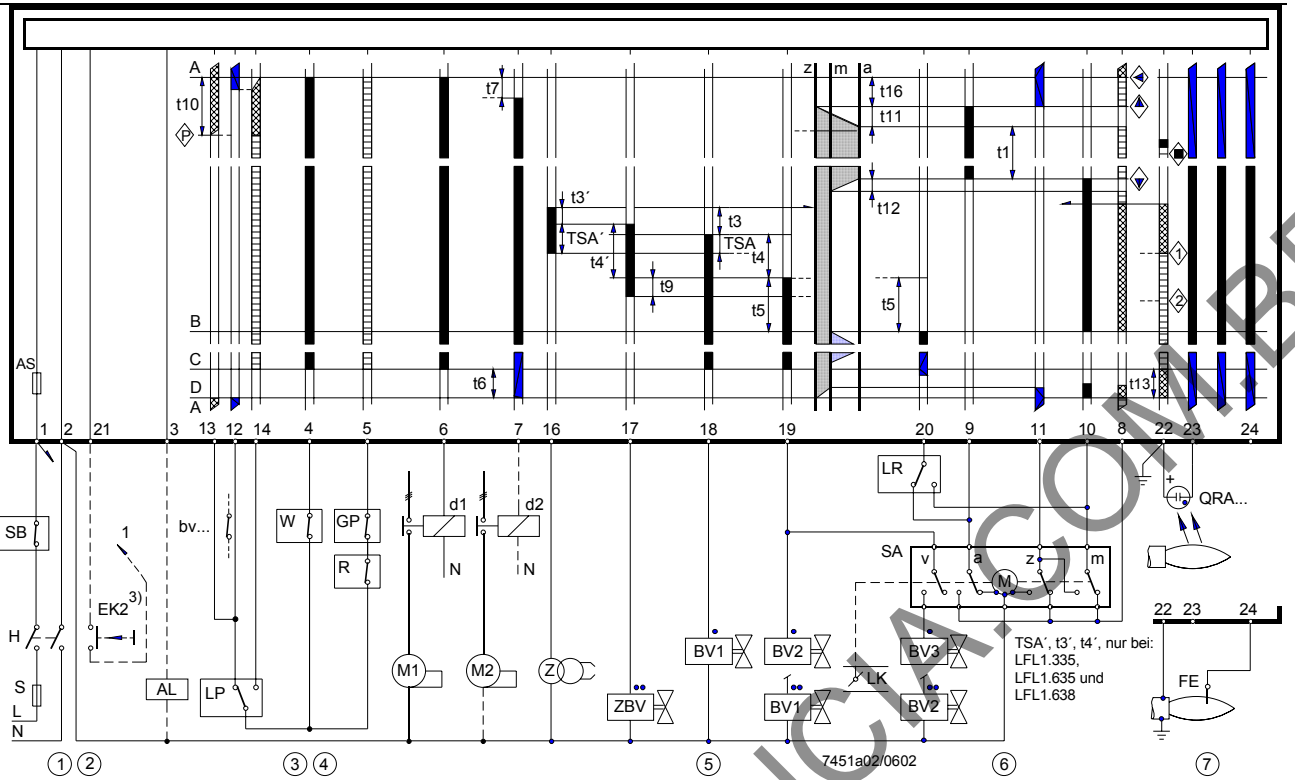

Connection diagram

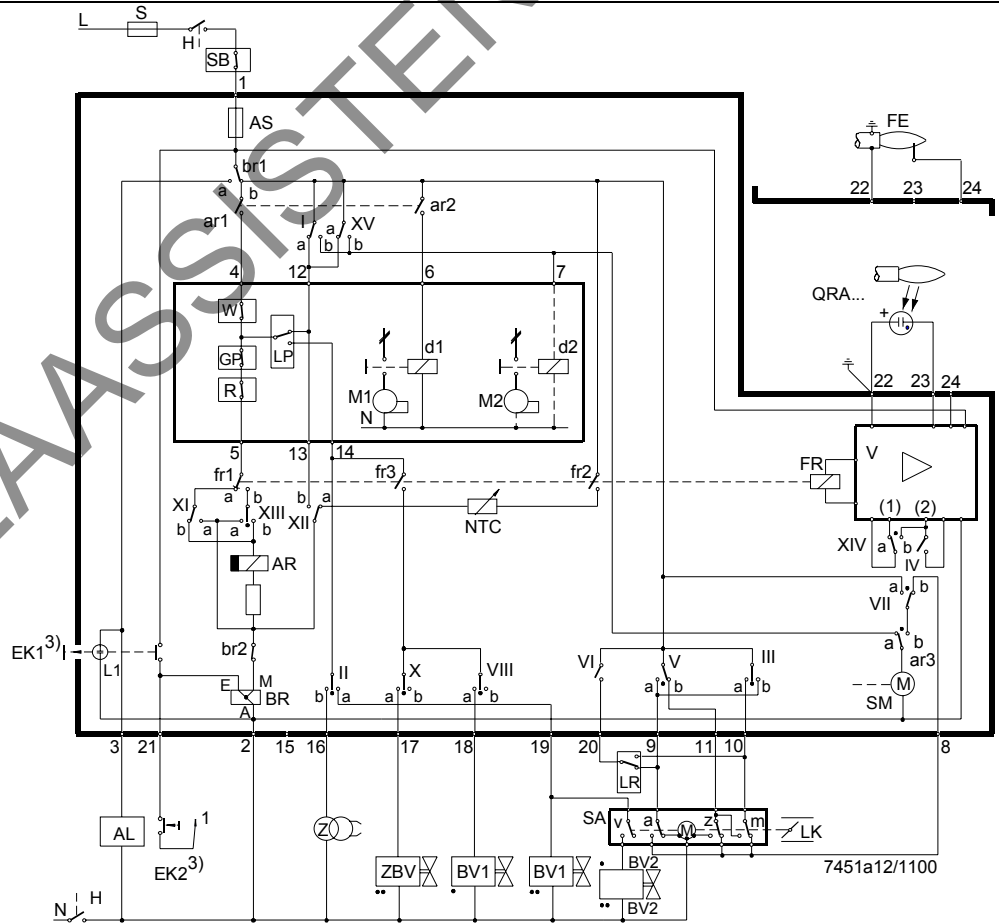

Do not press the lockout reset button for more than 10 seconds!  
For the connection of the safety shutoff valve, refer to the plant diagram provided by the burner manufacturer.

## Program sequence



«TSA'», «t3'» and «t4'»:

These times only apply to burner controls of the 01 series (LFL1.335, LFL1.635, and LFL1.638). They do not apply to burner controls of the 02 series since cams X and VIII of these types of LFL1... perform simultaneous switching actions.



## Legend

a	Changeover end switch for air damper's OPEN position	m	Changeover auxiliary switch for the air damper's MIN position
AL	Remote lockout warning device (alarm)	M...	Fan or burner motor
AR	Load relay with contacts «ar...»	NTC	NTC resistor
AS	Unit fuse	QRA...	UV detector
BR	Lockout relay with contacts «br...»	R	Control thermostat or pressurestat
BV...	Fuel valve	RV	Modulating fuel valve
bv...	Control contact for the CLOSED position of gas valves	S	Fuse
d...	Contact or relay	SA	Air damper actuator
EK...	Lockout reset button	SB	Safety limiter
FE	Ionization probe	SM	Synchronous motor of sequence switch
FR	Flame relay with contacts «fr...»	v	In the actuator: Changeover auxiliary switch for the position-dependent release of fuel
GP	Gas pressure switch	V	Flame signal amplifier
H	Main isolator	W	Limit thermostat or pressure switch
L1	Fault signal lamp	z	In the actuator: End switch for the air damper's CLOSED position
L3	Operational readiness indication	Z	Ignition transformer
LK	Air damper	ZBV	Pilot gas valve
LP	Air pressure switch		
LR	Load controller		

■ Control signals of the LFL1...

▨ Permissible input signals

▤ Required input signals:

If these signals are not present during ▨ or ▤, the burner control will interrupt the startup sequence or initiate lockout

TSA	Ignition safety time	t8	Duration of startup sequence (without «t11» and «t12»)
TSA'	Ignition safety time or first safety time (startup with burners using pilot burners)	t9	Second safety time with burners using pilot burners
t1	Prepurge time with air damper open	t10	Interval from start to the beginning of the air pressure check, excluding running time of air damper
t3	Preignition time	t11	Air damper running time to the OPEN position
t4	Interval between voltage at terminals 18 and 19	t12	Air damper running time to the low-fire position MIN
t4'	Interval between start of TSA' and release of valve at terminal 19	t13	Permissible afterburn time
t5	Interval between power at terminals 19 and 20	t16	Interval until OPEN command for the air damper is given
t6	Postpurge time (with «M2»)	t20	Interval to the self-shutdown of the sequence switch after startup
t7	Interval between start command and power at terminal 7 (start delay for «M2»)		

• Valid for expanding flame burners

•• Valid for interrupted pilot burners

(1) Input for increasing the operating voltage for the QRA... (detector test)

(2) Input for forced energizing of the flame relay during the functional test of the flame supervision circuit (contact XIV) and during safety time «TSA» (contact IV)

## Connection examples

Doubling the safety time with expanding flame burners

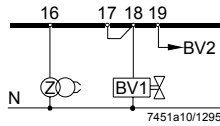

Only with burner controls of the 01 series.

This circuit change (linking terminals 17 and 18) reduces the preignition time by 50 %.

Extension of the safety time is only permitted if in compliance with the relevant national standards.

Burner without air damper

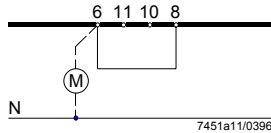

If the case of burners with no air damper (or with an air damper not controlled and monitored by the burner control), terminals 8 and 6 must be linked, as otherwise the burner control will not be able to start the burner.

2-stage expanding flame burner

Load control by a 2-position controller. The air damper is closed during burner off periods.

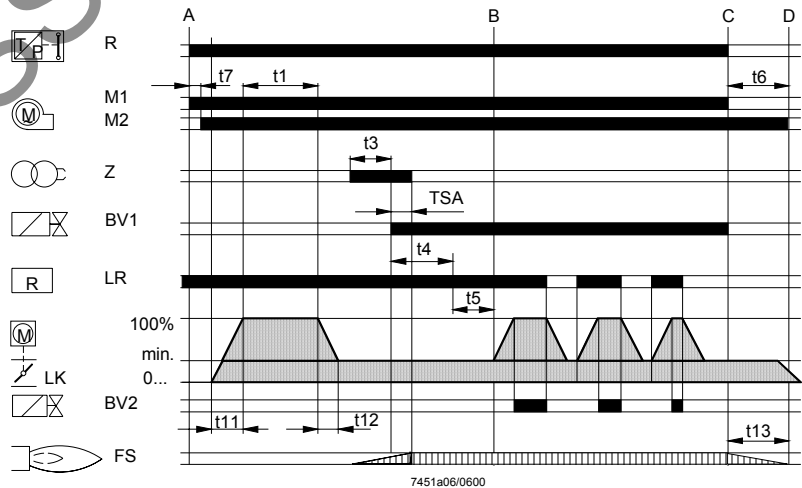
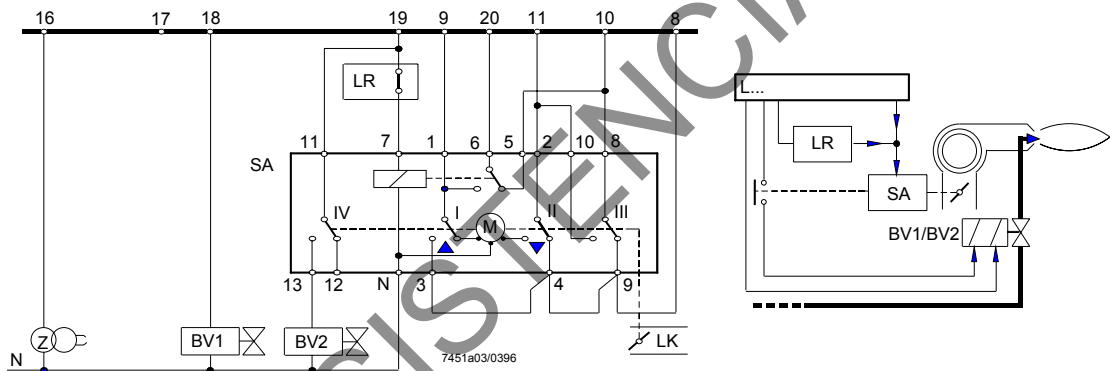

Control of actuator «SA» according to the single-wire principle (actuator «SA»: E.g. SQN3... as per Data Sheet 7808). For other connections, refer to «Connection diagrams».

Connection examples (cont'd)

**Modulating expanding flame burner**

Load control by a modulating controller with galvanically separated control contacts for the positioning directions OPEN or CLOSE.

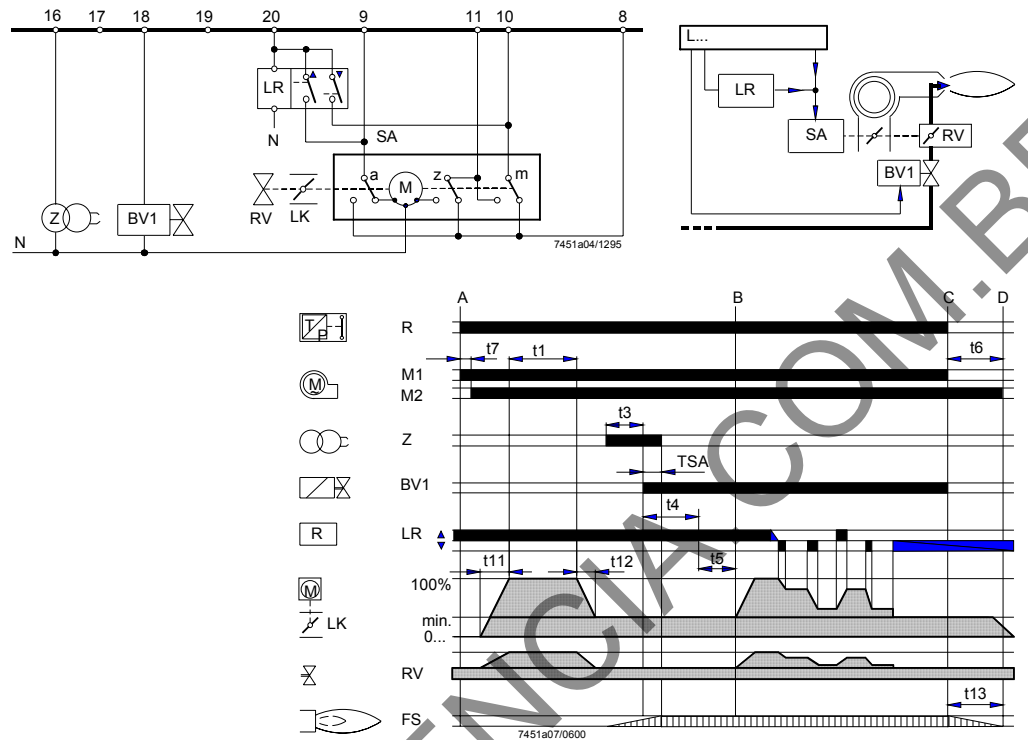

The air damper is kept closed during burner off periods. For other connections, refer to «Connection diagrams».

**2-stage interrupted pilot burner (burner with pilot burner)**

Controlled and supervised by a burner control of the 01 series.

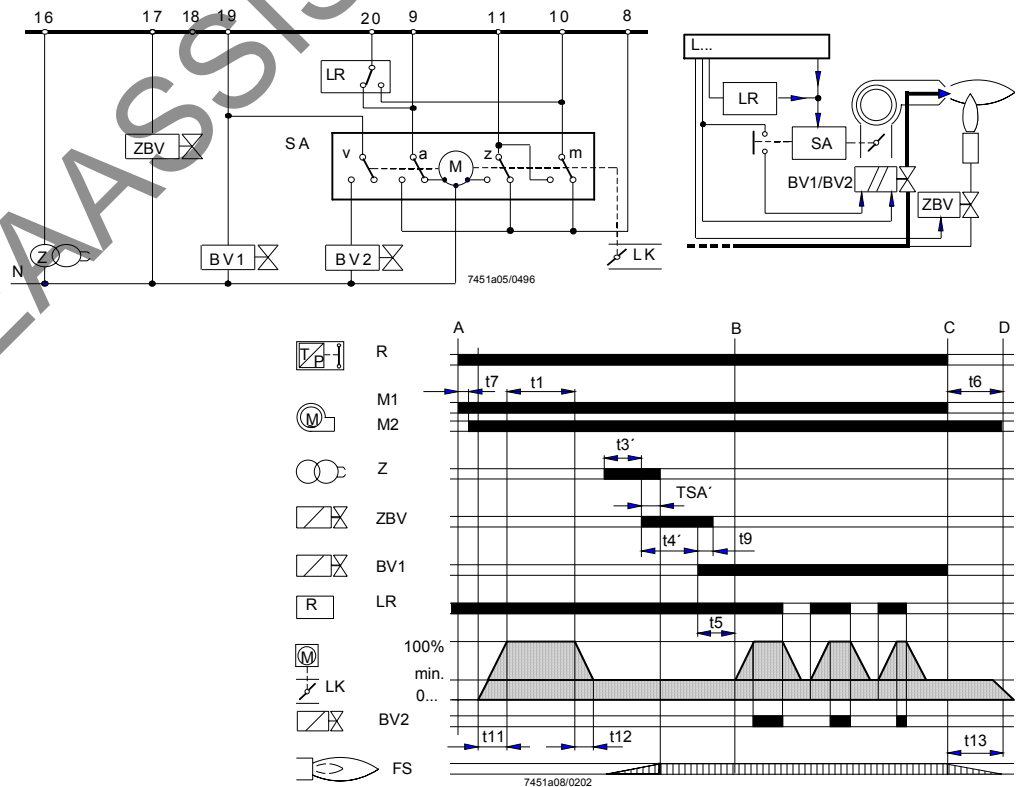

The air damper is kept closed during burner off periods. For other connections, refer to «Connection diagrams».

**Dimensions**

Dimensions in mm

LFL1... with plug-in  
base AGM...

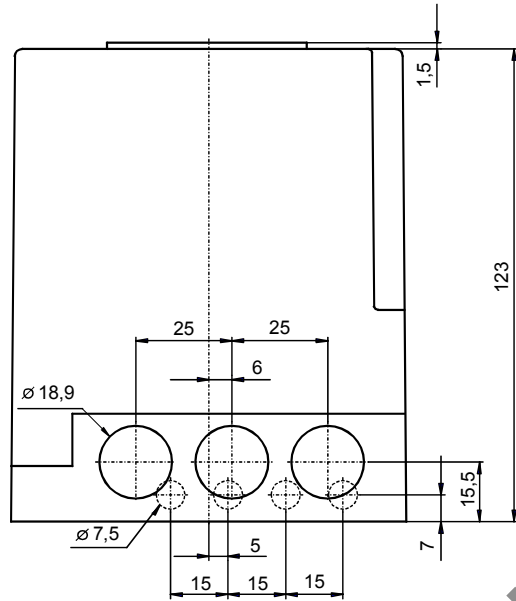

7451m02/0602

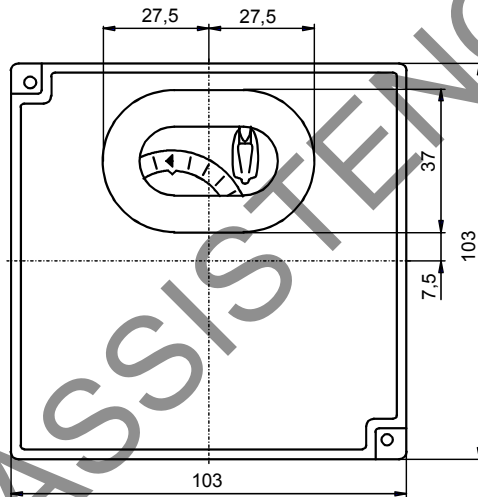

Plug-in base AGM...  
(Pg11 or M16 threads)

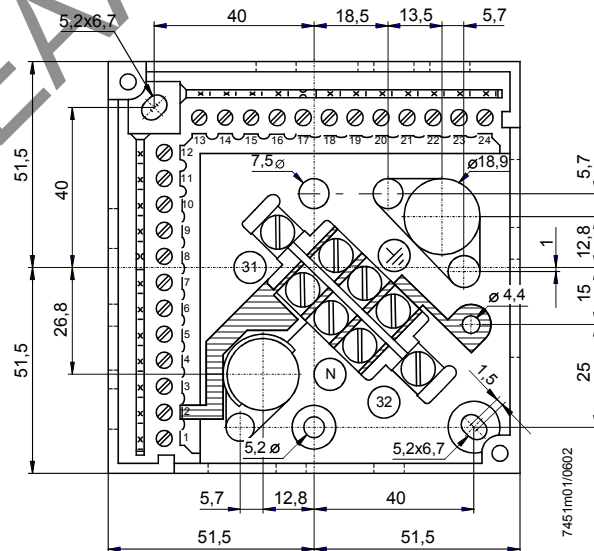

7451m01/0602

©2003 Siemens Building Technologies  
Subject to change!