

Tampa e subtampa

Vista Lateral

Tampa Inox

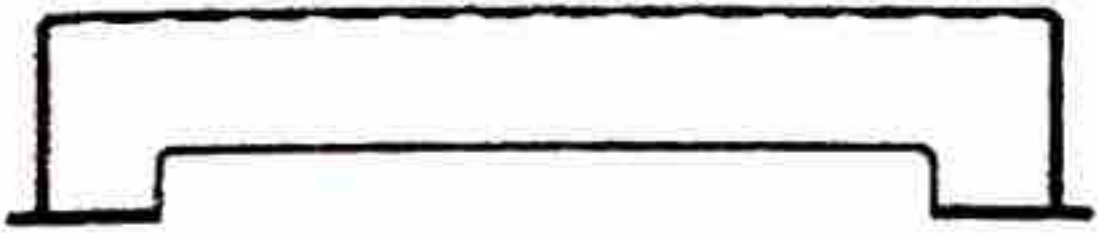

Subtampa Inox Oculta



Tampa Fun PVC (Vazado)

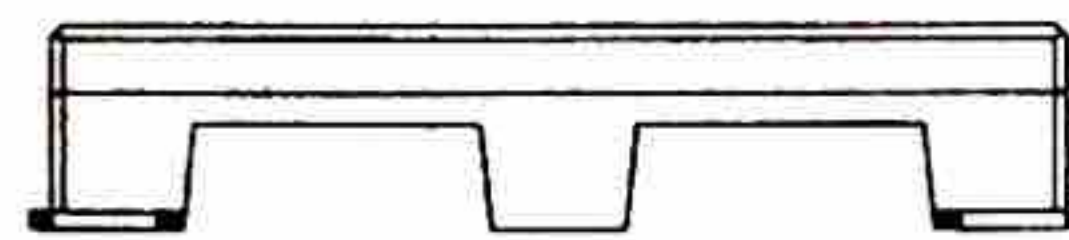

Subtampa Fit PVC (Oculto)

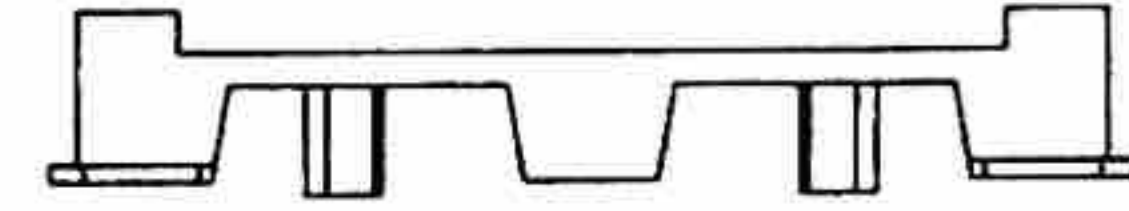

Vista Superior

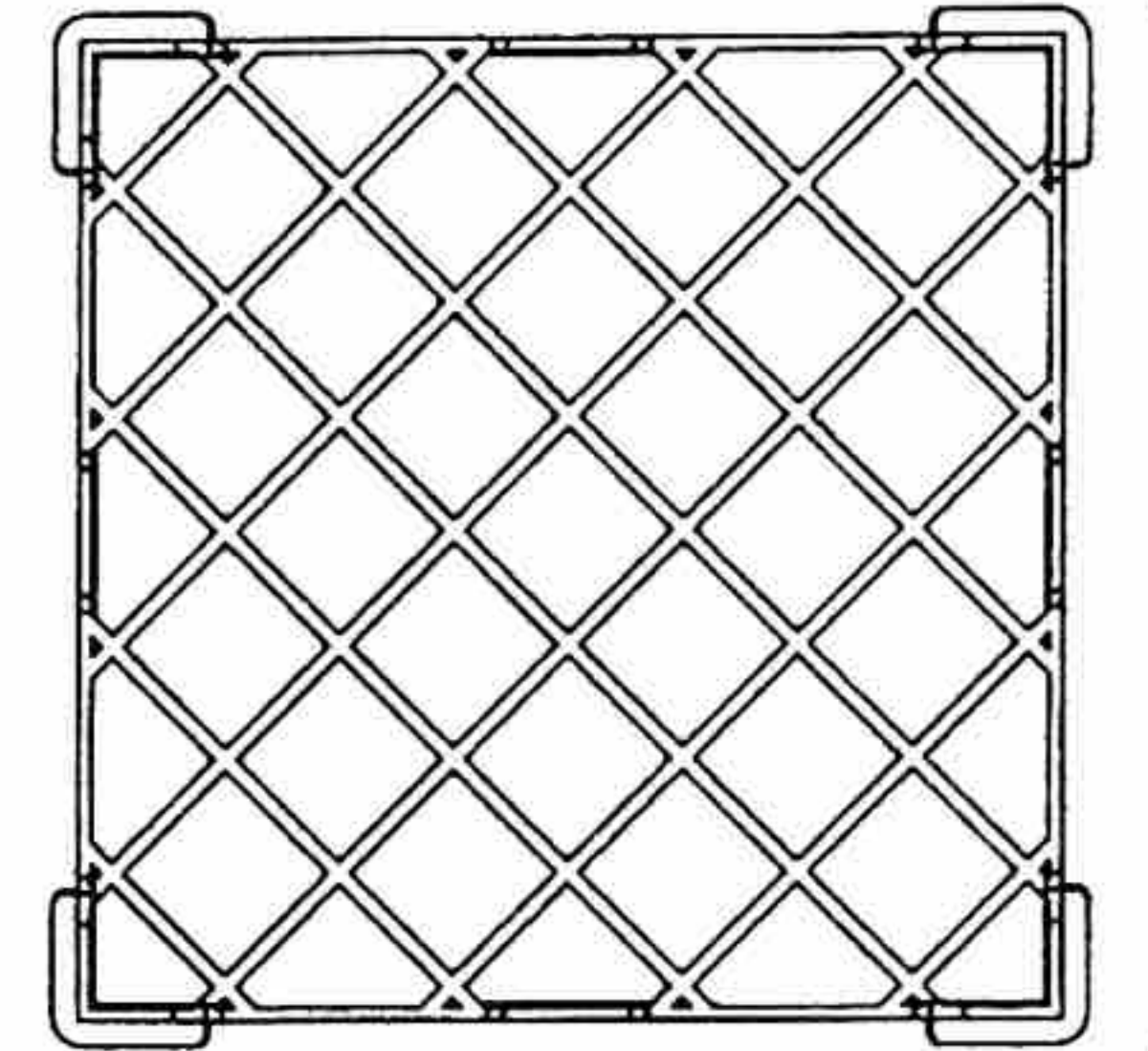
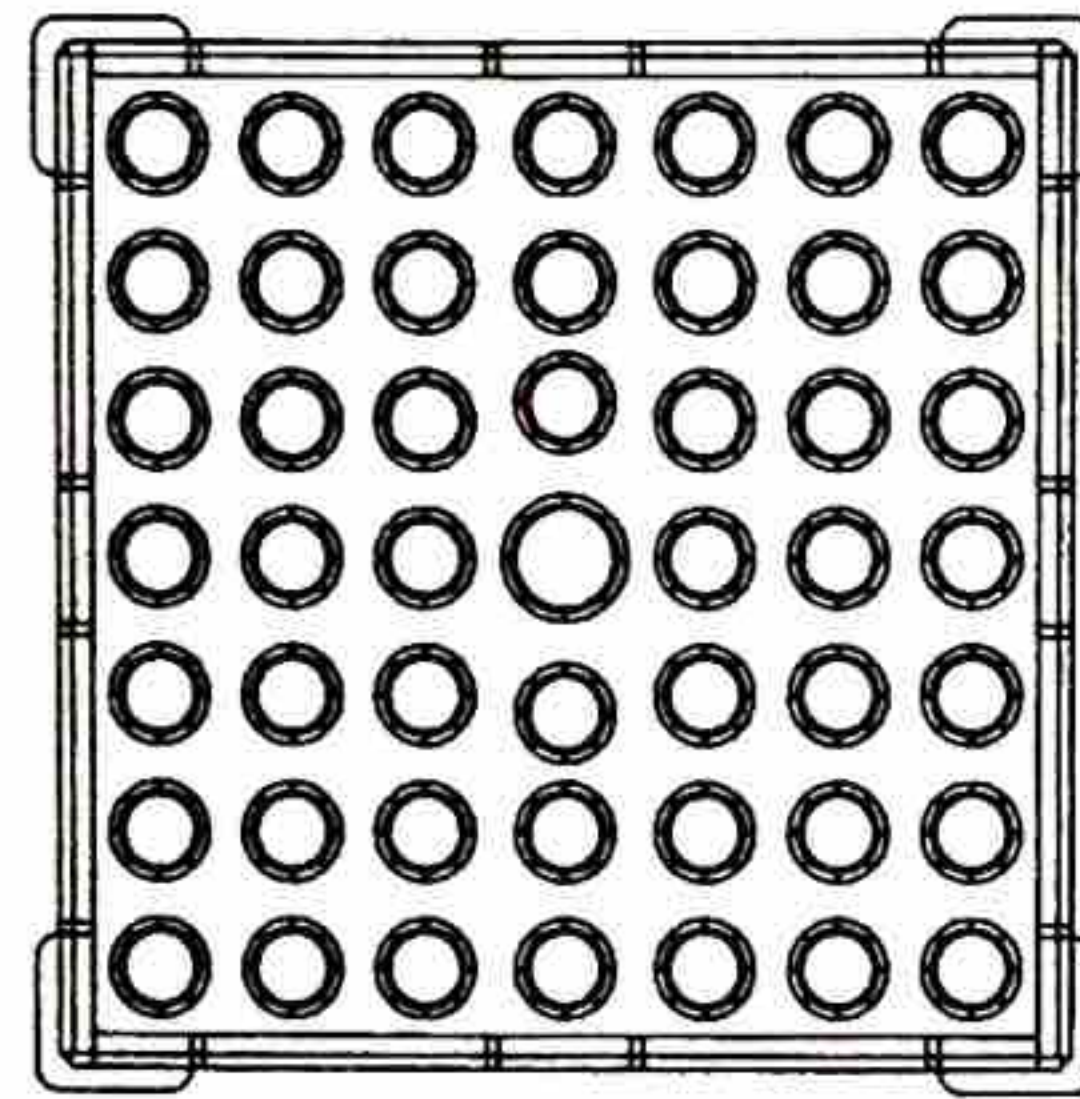
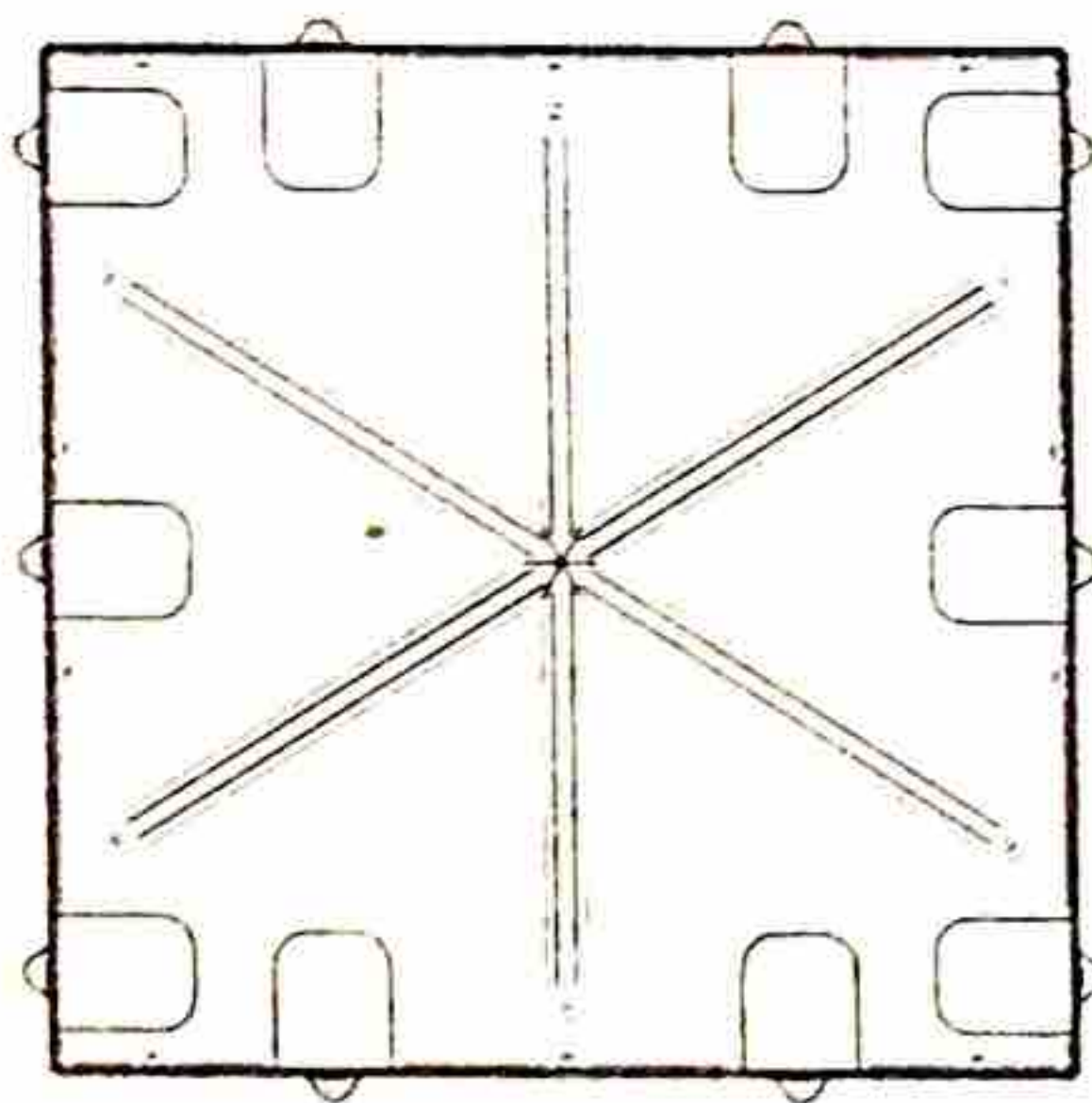
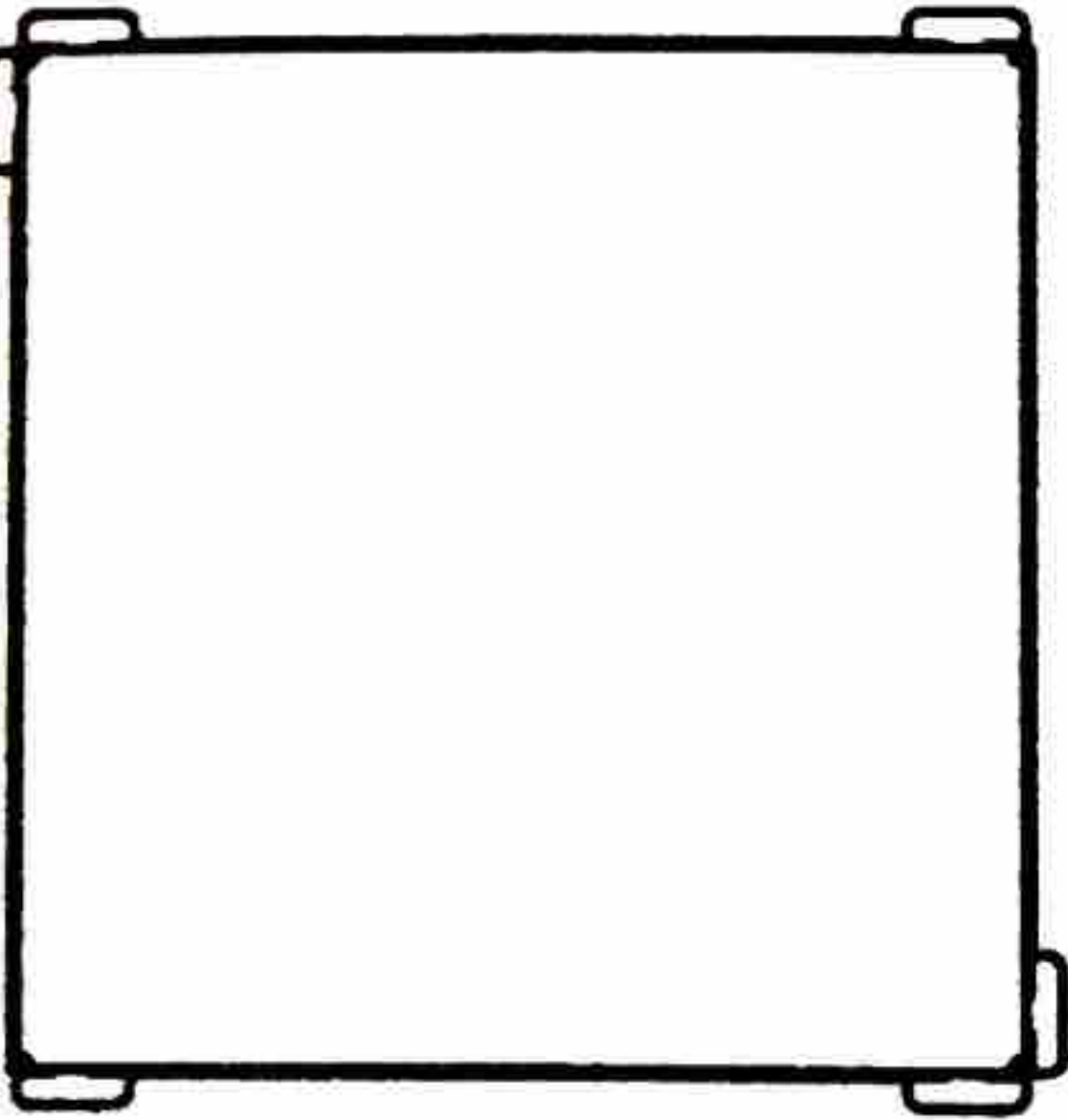

160 mm

Modelo Square Fit não acompanha Fecha Ralo e adaptador Square.

Base

Vista Superior

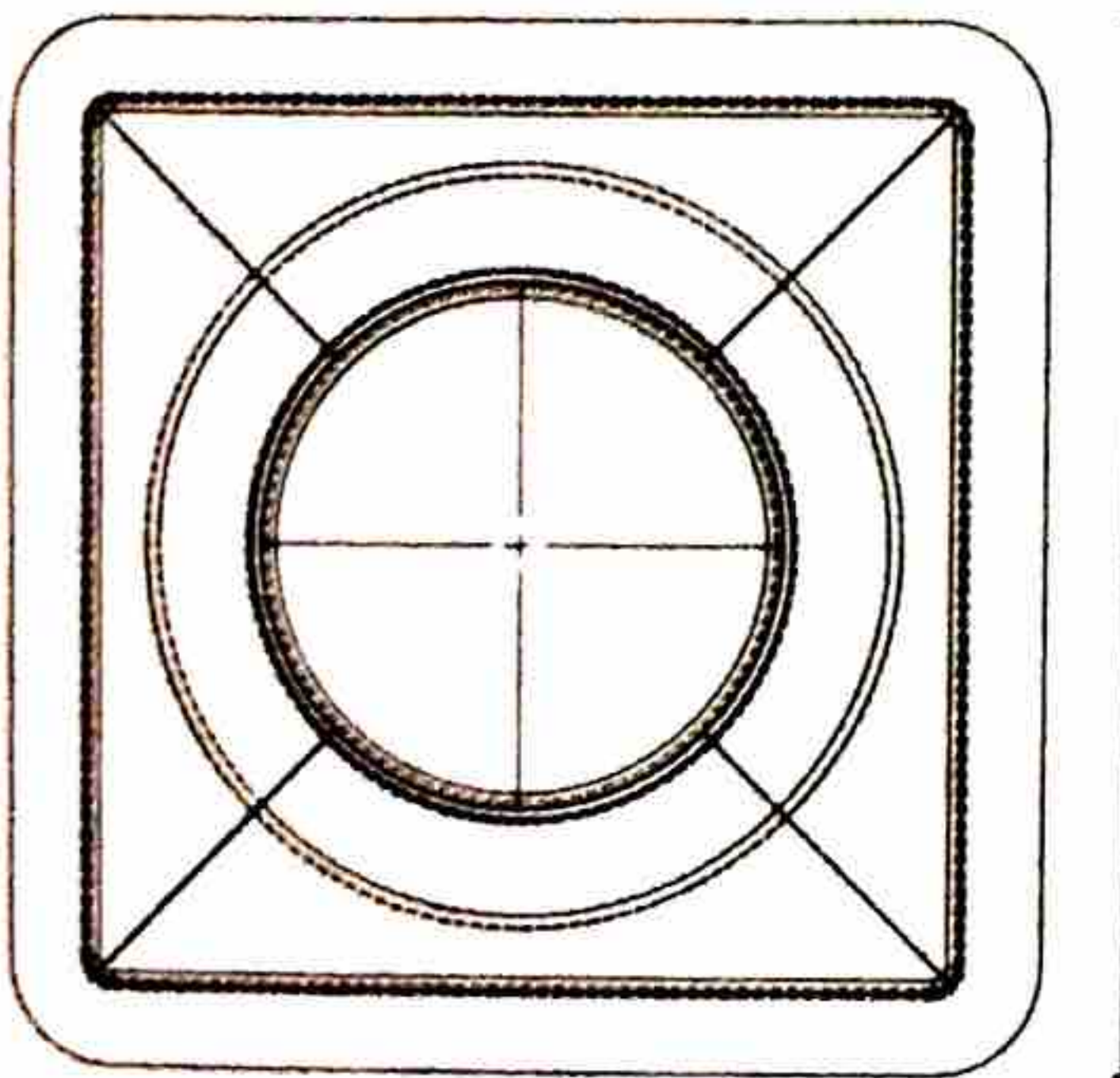

195 mm

Vista Frontal

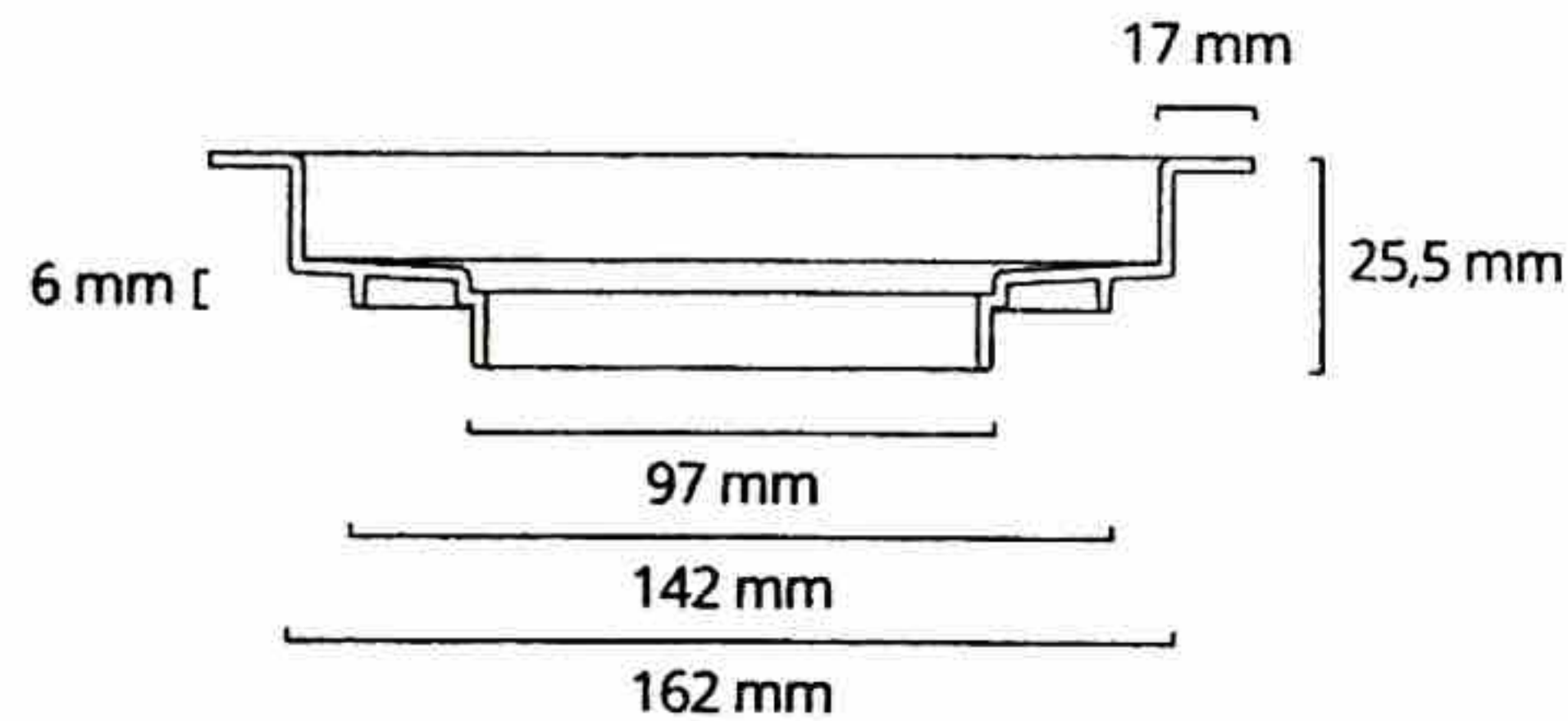

Opções de cores Modelo Fun (Vazado)

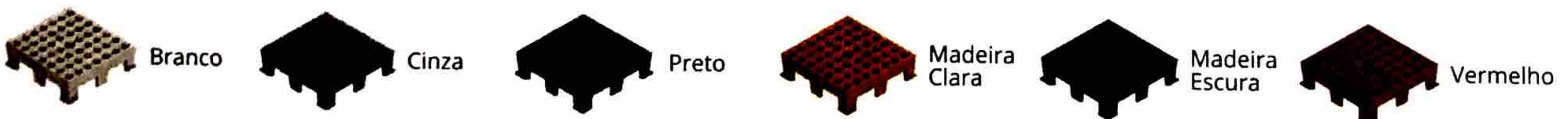

Materiais: base em PVC. Caixa sifonada: acoplável em caixas sifonadas de 100 mm, de 150 mm e compatível com tubo de 50 mm. Tampa Inox: Aço Inox 304 Escovado. Tampas Fun: PVC de alta resistência e proteção UV (exceto amadeiradas). Subtampa: aço inox 304 (modelo Oculto) e PVC (modelo Fit). Essa peça funciona como berço para acomodar uma tira de piso colado como acabamento final. Consulte a página de acessórios. Grade interna, ventosa e Fecha Ralo acompanham o produto. Para instalação em tubo de 50mm necessário utilizar o acessório Adaptador Square. Produto patenteado.