



HPE OfficeConnect 1420 Switch Series

Quick Setup Guide



5998-5750t

The information in this document is subject to change without notice.
© Copyright 2016 Hewlett Packard Enterprise Development LP
Part number: 5998-5750t

Hewlett Packard Enterprise 3000 Hanover Street Palo Alto, CA 94304

Product list

The HPE OfficeConnect 1420 Switch Series includes the models in [Table 1](#).

Table 1 Product list

Product code	Description	RMN
JH327A	HPE OfficeConnect 1420 5G Switch	HNGZA-HA0026
JH328A	HPE OfficeConnect 1420 5G PoE+ (32W) Switch	HNGZA-HA0027
JH329A	HPE OfficeConnect 1420 8G Switch	HNGZA-HA0028
JH330A	HPE OfficeConnect 1420 8G PoE+ (64W) Switch	HNGZA-HA0029
JH016A	HPE OfficeConnect 1420 16G Switch	HNGZA-HA0020
JG708B	HPE OfficeConnect 1420 24G Switch	HNGZA-HA0024
JH017A	HPE OfficeConnect 1420 24G 2SFP Switch	HNGZA-HA0021
JH018A	HPE OfficeConnect 1420 24G 2SFP+ Switch	HNGZA-HA0022
JH019A	HPE OfficeConnect 1420 24G PoE+ (124W) Switch	HNGZA-HA0023

Installation tools



Phillips
screwdriver



ESD wrist strap

NOTE:

The installation tools are user supplied.

Introduction to installation accessories

For JH016A, JH017A, JH018A, JH019A, and JG708B:



M4 screw



M6 screw



Cage nut (user supplied)



Grounding cable

For JH016A, JH327A, JH328A, JH329A, and JH330A:



Rubber feet

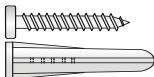

Wall mounting kit

For JH017A, JH018A, JH019A, and JG708B:



Mounting bracket



Rubber feet

For JH016A:

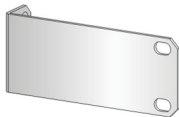

Mounting bracket

Installing the switch



CAUTION:

Before installation, wear an ESD wrist strap, and make sure the wrist strap has good skin contact and is reliably grounded.

Rack mounting

Only the JH016A, JH017A, JH018A, JH019A, and JG708B support rack mounting.

1. Attach the mounting brackets to the switch by using M4 screws.

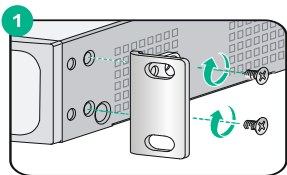

(For JH017A, JH018A, JH019A, and JG708B)

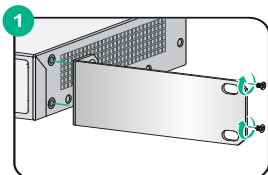

(For JH016A)

2. Install cage nuts.
3. Mount the switch in a rack and secure the switch by using M6 screws.

Install cage nuts

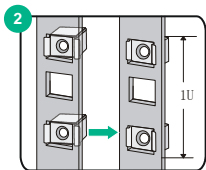

Mount the switch in a rack by using M6 screws

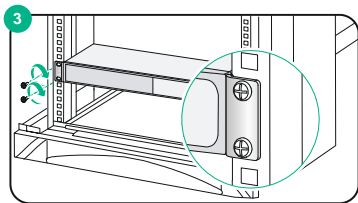

Horizontal surface mounting

1. Attach the rubber feet to the four round holes in the chassis bottom.

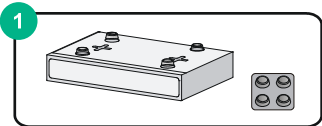

(For JH016A, JH327A, JH328A, JH329A, and JH330A)

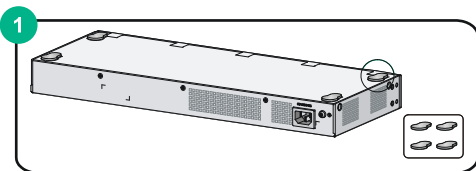

(For JH017A, JH018A, JH019A, and JG708B)

2. Place the switch upside up on the workbench.

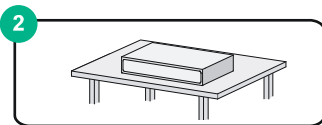

(For JH016A, JH327A, JH328A, JH329A, and JH330A)

2

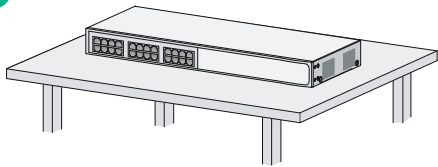

(For JH017A, JH018A, JH019A, and JG708B)

Wall mounting

Only the JH016A, JH327A, JH328A, JH329A, and JH330A can be installed on a wall. The installation hole spacing varies by switch model, as shown in [Table 2](#).

Table 2 Installation hole spacing for each model

Product code	Installation hole spacing
JH016A	160 mm (6.30 in)
JH327A	74 mm (2.91 in)
JH328A	90 mm (3.54 in)
JH329A	90 mm (3.54 in)
JH330A	90 mm (3.54 in)

This section uses the JH016A as an example.

To install a switch on a wall:

1. Drill two holes at the same height.
2. Insert one wall anchor into each hole until the anchors are flush with the wall surface. Drive one screw into each wall anchor, and tighten the screws just enough to keep it secure in the wall anchor.

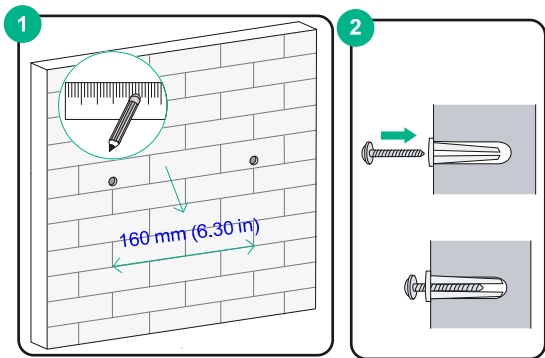

3. Align the two mounting holes in the switch chassis bottom with the two screws on the wall and hang the switch.

NOTE:

For wall mounting, the network ports can face upwards or downwards.

3

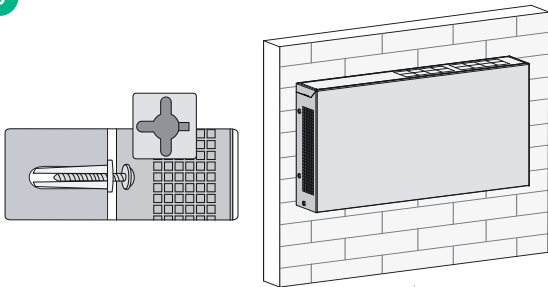

Under-table mounting

WARNING!

- Make sure the table is sturdy enough to support the weight of the switch and attached cables.
 - Ensure good ventilation to prevent overheating.
-

Only the JH016A, JH327A, JH328A, JH329A, and JH330A can be installed under a table. The installation hole spacing varies by switch model, as shown in [Table 2](#).

This section uses the JH016A as an example.

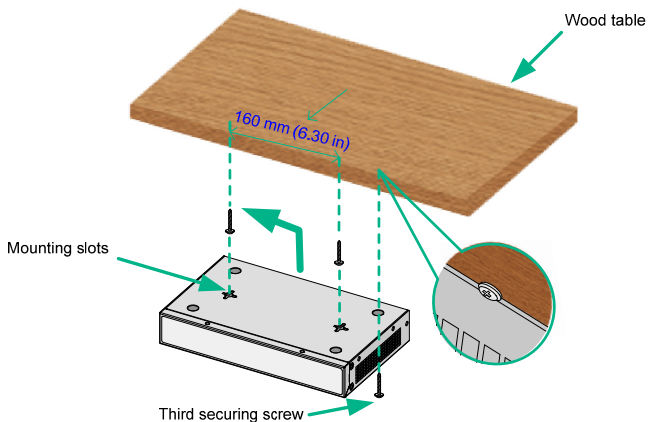

After installation, install the securing screw (included in the kit) to prevent switch movement.

Connecting the grounding cable



CAUTION:

Connect the grounding cable reliably to ensure lightning protection and electromagnetic shield (EMS) of your switch.

The grounding screw is not provided with the JH327A and JH329A switches.

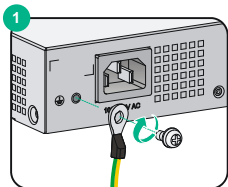

Connect the ring terminal of the grounding cable to the switch.

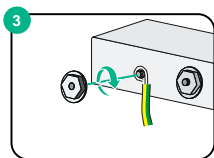
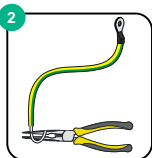

Connect the grounding cable to the grounding strip.

Connecting the power cord



WARNING!

To avoid bodily injury, first connect the power cord to the switch and then to the power supply system.

- Connect the AC power cord
Only the JH016A, JH017A, JH018A, JH019A, and JG708B support an AC power supply.

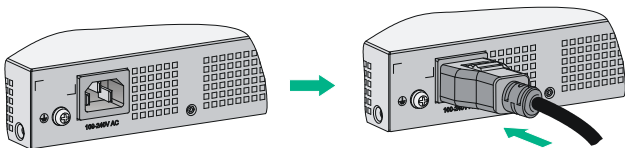

- Connect the power adapter.
Only the JH327A, JH328A, JH329A, and JH330A support a power adapter.

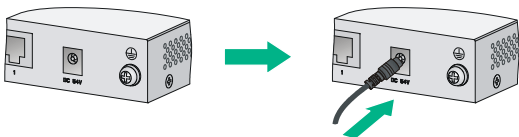

Connecting network cables

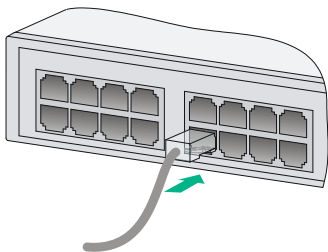

Documentation

To access documentation and support services, go to the Hewlett Packard Enterprise Support Center website:

www.hpe.com/support/hpesc