

International IR Rectifier

15ETH06 15ETH06S 15ETH06-1

Hyperfast Rectifier

Features

- Hyperfast Recovery Time
- Low Forward Voltage Drop
- Low Leakage Current
- 175°C Operating Junction Temperature
- Single Die Center Tap Module

$t_{rr} = 22\text{ns typ.}$
$I_{F(AV)} = 15\text{Amp}$
$V_R = 600\text{V}$

Description/ Applications

State of the art Hyperfast recovery rectifiers designed with optimized performance of forward voltage drop, Hyperfast recover time, and soft recovery.

The planar structure and the platinum doped life time control guarantee the best overall performance, ruggedness and reliability characteristics.





These devices are intended for use in PFC Boost stage in the AC-DC section of SMPS, inverters or as freewheeling diodes.

The IR extremely optimized stored charge and low recovery current minimize the switching losses and reduce over dissipation in the switching element and snubbers.

Absolute Maximum Ratings

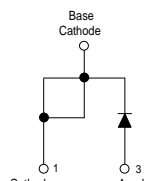
Parameters	Max	Units
V_{RRM} Peak Repetitive Peak Reverse Voltage	600	V
$I_{F(AV)}$ Average Rectified Forward Current @ $T_C = 140^\circ\text{C}$	15	A
I_{FSM} Non Repetitive Peak Surge Current @ $T_J = 25^\circ\text{C}$	120	
I_{FM} Peak Repetitive Forward Current	30	
T_J, T_{STG} Operating Junction and Storage Temperatures	- 65 to 175	$^\circ\text{C}$

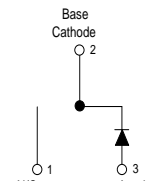
Case Styles

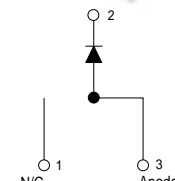
15ETH06	15ETH06S	15ETH06-1
  TO-220AC	  D²PAK	  TO-262

Electrical Characteristics @ T_J = 25°C (unless otherwise specified)

Parameters	Min	Typ	Max	Units	Test Conditions
V _{BR} , V _r Breakdown Voltage, Blocking Voltage	600	-	-	V	I _R = 100μA
V _F Forward Voltage	-	1.8	2.2	V	I _F = 15A, T _J = 25°C
	-	1.3	1.6	V	I _F = 15A, T _J = 150°C
I _R Reverse Leakage Current	-	0.2	50	μA	V _R = V _R Rated
	-	30	500	μA	T _J = 150°C, V _R = V _R Rated
C _T Junction Capacitance	-	20	-	pF	V _R = 600V
L _S Series Inductance	-	8.0	-	nH	Measured lead to lead 5mm from package body

Dynamic Recovery Characteristics @ T_C = 25°C (unless otherwise specified)

Parameters	Min	Typ	Max	Units	Test Conditions	
t _{rr} Reverse Recovery Time	-	22	30	ns	I _F = 1A, di _F /dt = 100A/μs, V _R = 30V	
	-	28	35		I _F = 15A, di _F /dt = 100A/μs, V _R = 30V	
	-	29	-	ns	T _J = 25°C	
	-	75	-		T _J = 125°C	
I _{RRM} Peak Recovery Current	-	3.5	-	A	T _J = 25°C	
	-	7	-		T _J = 125°C	
Q _{rr} Reverse Recovery Charge	-	57	-	nC	T _J = 25°C	
	-	300	-		T _J = 125°C	
t _{rr} Reverse Recovery Time	-	51	-	ns	T _J = 125°C	
I _{RRM} Peak Recovery Current	-	20	-			A
Q _{rr} Reverse Recovery Charge	-	580	-			nC

Thermal - Mechanical Characteristics

Parameters	Min	Typ	Max	Units
T _J Max. Junction Temperature Range	-	-	175	°C
T _{Stg} Max. Storage Temperature Range	-65	-	175	
R _{thJC} Thermal Resistance, Junction to Case Per Leg	-	1.0	1.3	°C/W
R _{thJA} ① Thermal Resistance, Junction to Ambient Per Leg	-	-	70	
R _{thCS} ② Thermal Resistance, Case to Heatsink	-	0.5	-	
Weight	-	2.0	-	g
	-	0.07	-	(oz)
Mounting Torque	6.0	-	12	Kg-cm
	5.0	-	10	lbf.in

① Typical Socket Mount

② Mounting Surface, Flat, Smooth and Greased

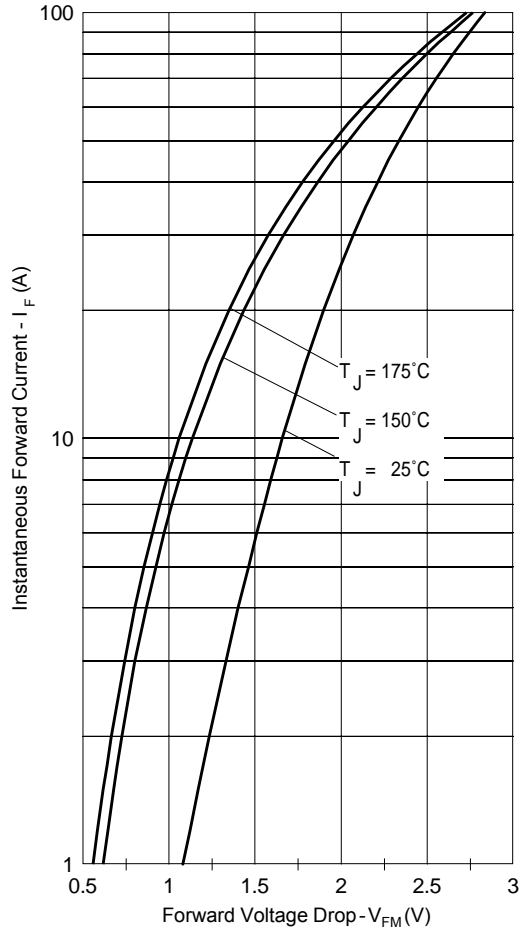

Fig. 1 - Typical Forward Voltage Drop Characteristics

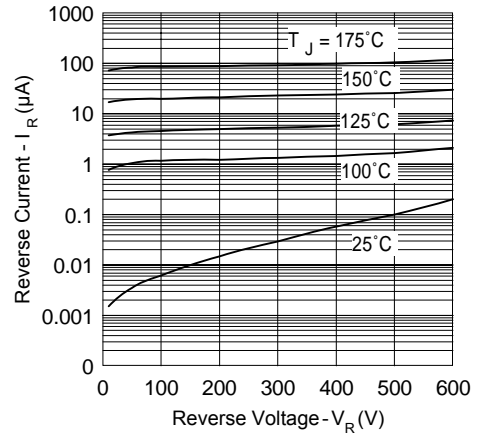

Fig. 2 - Typical Values Of Reverse Current Vs. Reverse Voltage

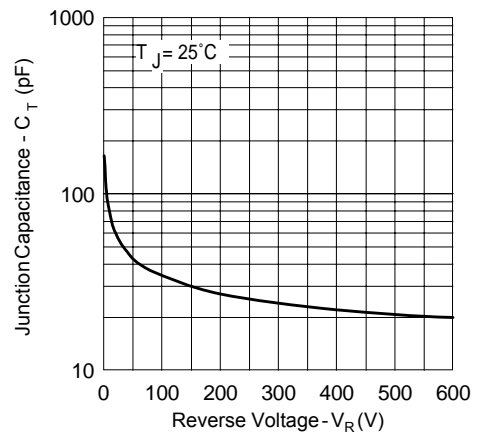

Fig. 3 - Typical Junction Capacitance Vs. Reverse Voltage

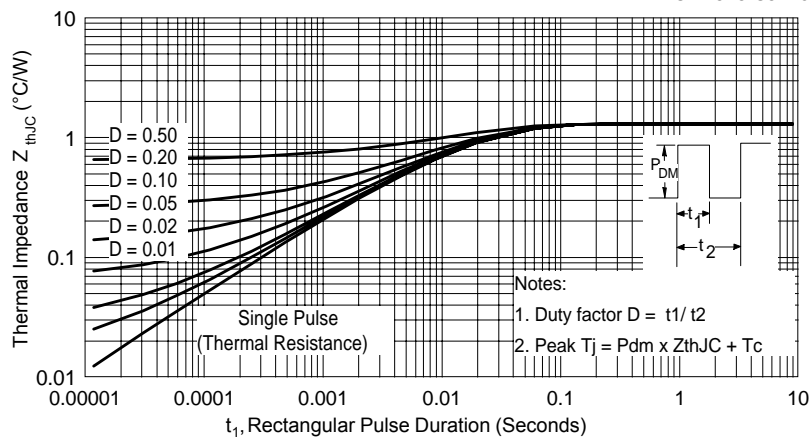

Fig. 4 - Max. Thermal Impedance Z_{thJC} Characteristics

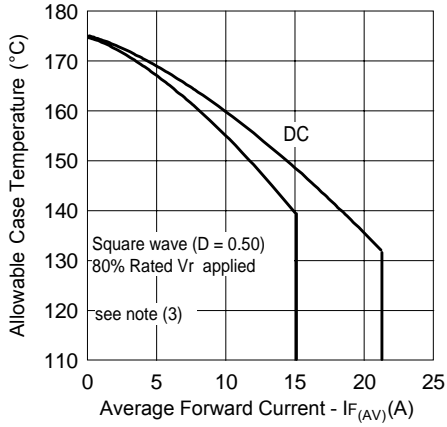

Fig. 5 - Max. Allowable Case Temperature Vs. Average Forward Current

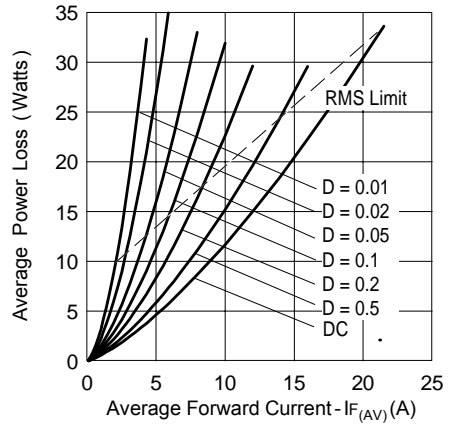

Fig. 6 - Forward Power Loss Characteristics

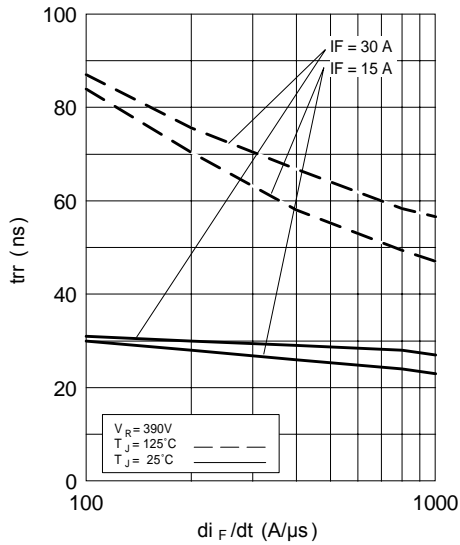

Fig. 7 - Typical Reverse Recovery vs. di_F/dt

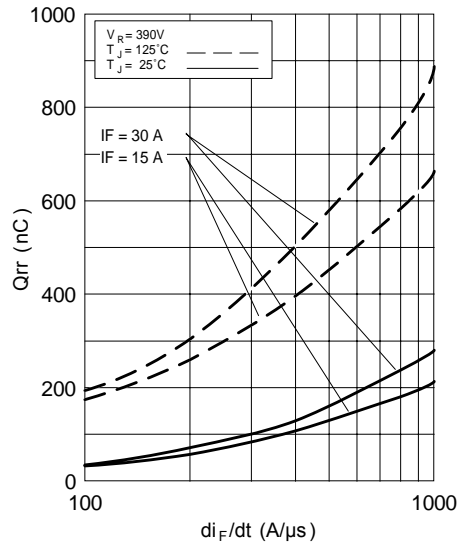

Fig. 8 - Typical Stored Charge vs. di_F/dt

(3) Formula used: $T_C = T_J - (Pd + Pd_{REV}) \times R_{thJC}$;
 $Pd = \text{Forward Power Loss} = I_{F(AV)} \times V_{FM} @ (I_{F(AV)}/D)$ (see Fig. 6);
 $Pd_{REV} = \text{Inverse Power Loss} = V_{R1} \times I_R (1 - D)$; $I_R @ V_{R1} = \text{rated } V_R$

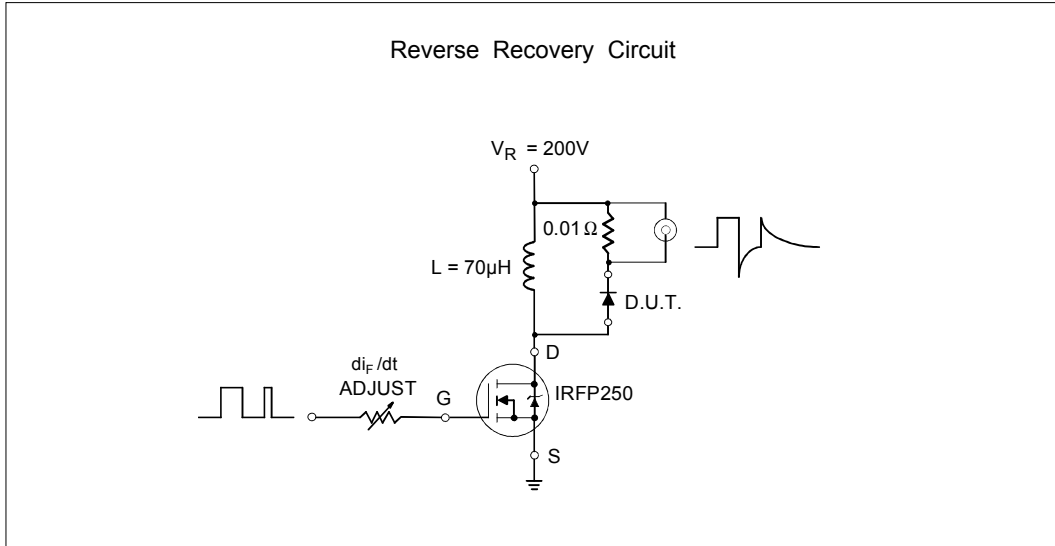

Fig. 9- Reverse Recovery Parameter Test Circuit

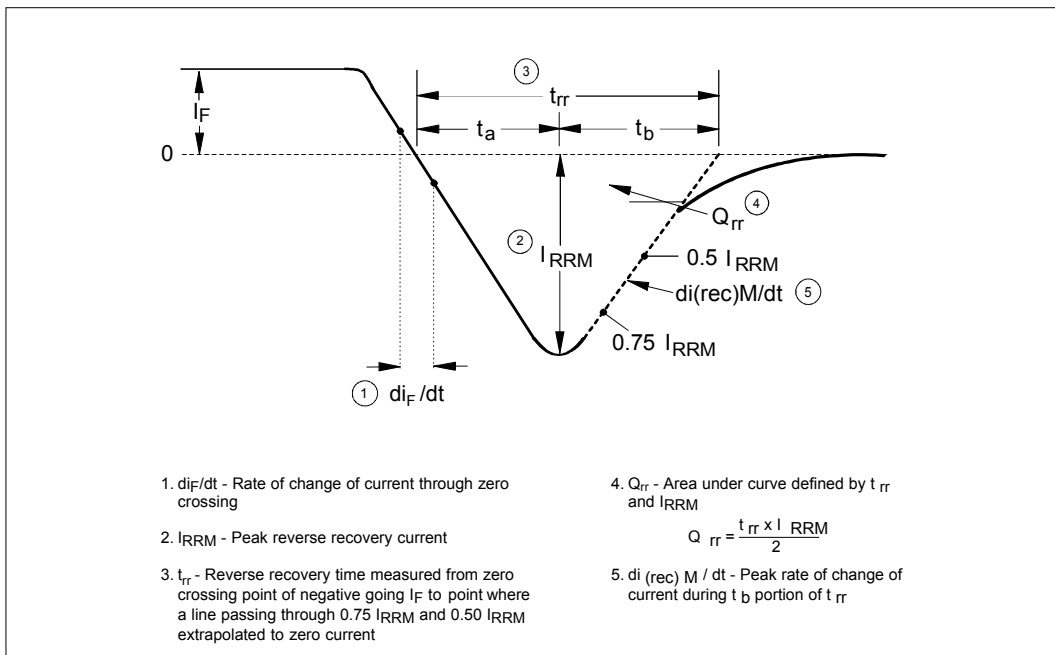
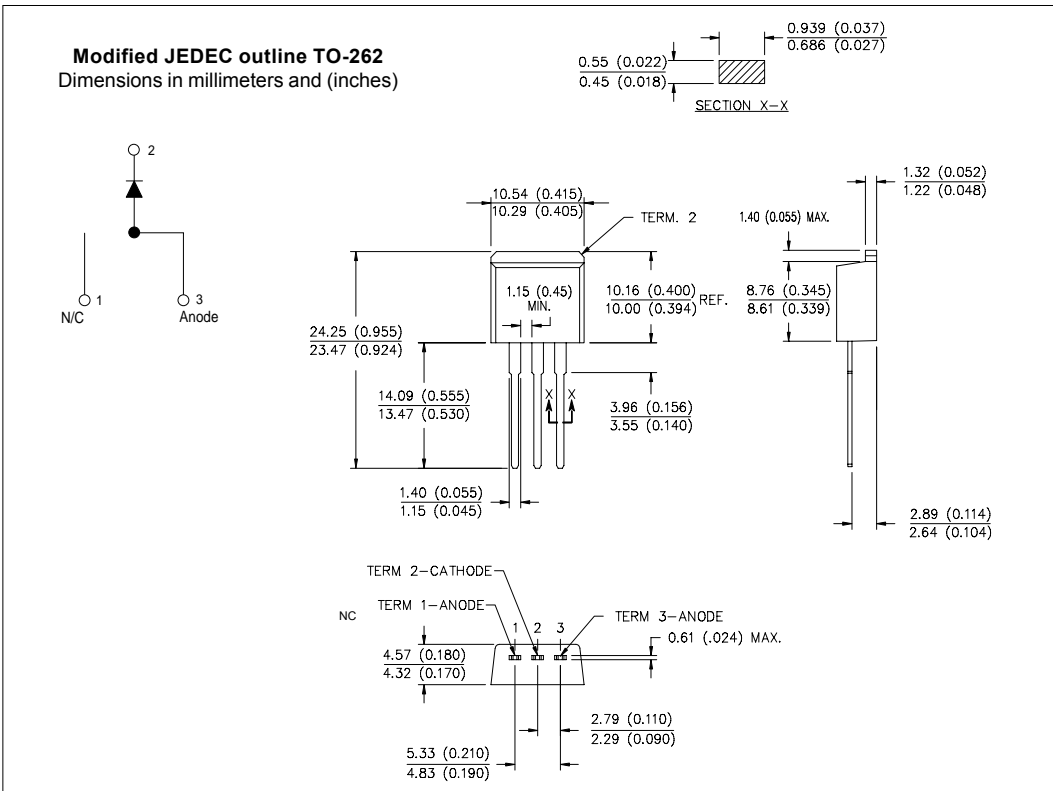
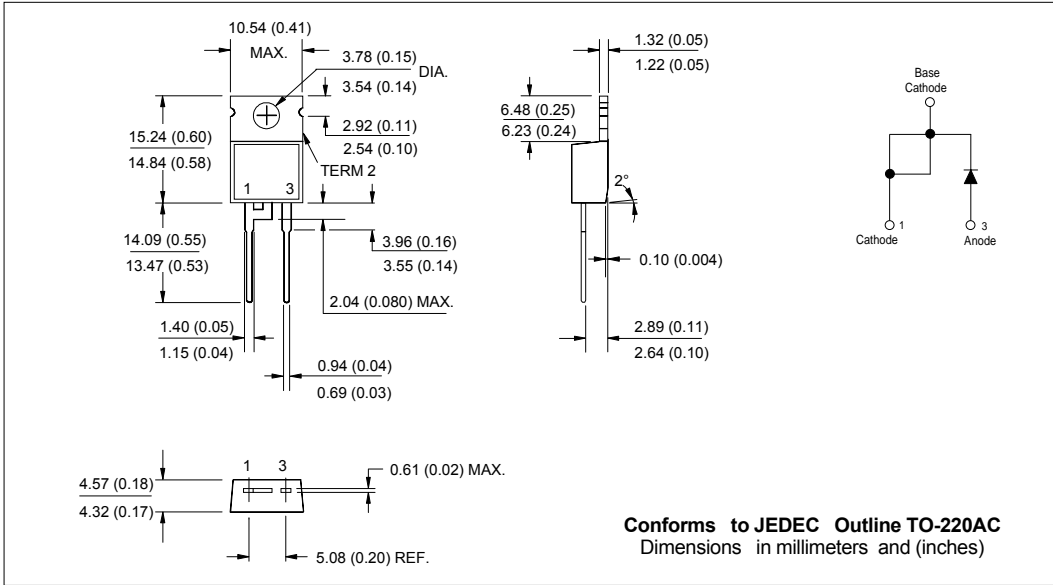
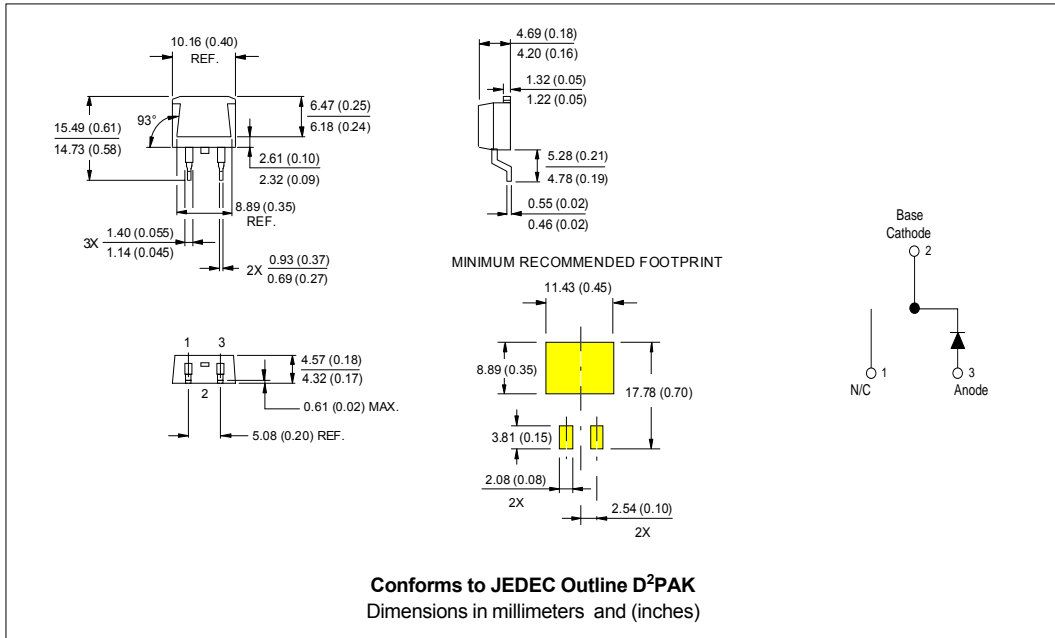

Fig. 10 - Reverse Recovery Waveform and Definitions

Outline Table



Outline Table



Ordering Information Table

Device Code

15	E	T	H	06	- 1
①	②	③	④	⑤	⑥

- 1** - Current Rating (15 = 15A)
- 2** - E = Single Diode
- 3** - T = TO-220, D²Pak
- 4** - H = HyperFast Recovery
- 5** - Voltage Rating (06 = 600V)
- 6** - "-1" = TO-262 Option
 S = D²Pak
 None = TO-220AC

15ETH06, 15ETH06S, 15ETH06-1

Bulletin PD-20749 rev. D 08/01

International
IOR Rectifier

Data and specifications subject to change without notice.
This product has been designed and qualified for Industrial Level.
Qualification Standards can be found on IR's Web site.

International
IOR Rectifier

IR WORLD HEADQUARTERS: 233 Kansas St., El Segundo, California 90245, USA Tel: (310) 252-7105

TAC Fax: (310) 252-7309

Visit us at www.irf.com for sales contact information. 08/01

This datasheet has been download from:

www.datasheetcatalog.com

Datasheets for electronics components.